

650V Silicon Carbide Schottky Diode

$V_{RRM} = 650\text{ V}$
$I_F (T_c=150^\circ\text{C}) = 4.8\text{ A}$
$Q_c = 9.5\text{ nC}$

Features

- 650Volt Schottky Rectifier
- Shorter recovery time
- Highspeed switching possible
- HighFrequency Operation
- TemperatureIndependent Switching Behavior
- Extremely Fast Switching
- Positive Temperature Coefficient on VF

Applications

- HVAC
- Switch Mode Power Supplies (SMPS)
- Boost diodes in PFC or DC/DC stages
- Free Wheeling Diodes in Inverter Stages
- AC/DC converters

Benefits

- Higher safety margin against overvoltage
- Improved efficiency all load conditions
- Increased efficiency compared to Silicon Diode alternatives
- Reduction of Heat Sink Requirements
- Parallel Devices Without Thermal Runaway
- Essentially No Switching Losses

Package



Type : TO-263-2L

1、 Cathode 2、 Anode

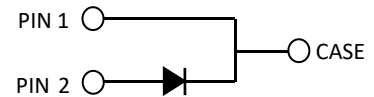

Maximum Ratings ($T_c = 25^\circ\text{C}$ unless otherwise specified)

Symbol	Parameter	Value	Unit	Test Conditions	Note
V_{RRM}	Repetitive Peak Reverse Voltage	650	V		
V_{RSM}	Surge Peak Reverse Voltage	650	V		
V_{DC}	DC Blocking Voltage	650	V		
I_F	Continuous Forward Current	4.8	A	$T_C=150^\circ\text{C}$	Fig. 7
I_{FRM}	Repetitive Peak Forward Surge Current	20	A	$T_C=25^\circ\text{C}$, $t_p=10\text{ ms}$, Half Sine Wave,	
I_{FSM}	Non-Repetitive Peak Forward Surge Current	26	A	$T_C=25^\circ\text{C}$, $t_p=10\text{ms}$, Half Sine Wave	
$I_{F,Max}$	Non-Repetitive Peak Forward Surge Current	200	A	$T_C=25^\circ\text{C}$, $t_p= 10\ \mu\text{s}$, Pulse	
P_{tot}	Power Dissipation	76.5 33.2	W	$T_C=25^\circ\text{C}$ $T_C=110^\circ\text{C}$	Fig. 6
$\int i^2 dt$	I^2t value	3.3	A^2s	$T_C=25^\circ\text{C}$, $t_p=10\text{ms}$	
T_J, T_{stg}	Operating Junction and Storage Temperature	-55 to +175	$^\circ\text{C}$		

Electrical Characteristics

Symbol	Parameter	Typ.	Max.	Unit	Test Conditions	Note
V_F	Forward Voltage	1.5 1.8	1.8 2.0	V	$I_F = 4\text{ A } T_J = 25^\circ\text{C}$ $I_F = 4\text{ A } T_J = 175^\circ\text{C}$	Fig. 1
I_R	Reverse Current	1 12	20 100	μA	$V_R = 650\text{ V } T_J = 25^\circ\text{C}$ $V_R = 650\text{ V } T_J = 175^\circ\text{C}$	Fig. 2
Q_C	Total Capacitive Charge	9.5		nC	$V_R = 400\text{ V}, T_J = 25^\circ\text{C}$ $Q_C = \int_0^{V_R} C(V) dV$	Fig. 4
C	Total Capacitance	185 19.0 16.7		pF	$V_R = 0\text{ V}, T_J = 25^\circ\text{C}, f = 1\text{ MHz}$ $V_R = 200\text{ V}, T_J = 25^\circ\text{C}, f = 1\text{ MHz}$ $V_R = 400\text{ V}, T_J = 25^\circ\text{C}, f = 1\text{ MHz}$	Fig. 3
E_C	Capacitance Stored Energy	2.4		μJ	$V_R = 400\text{ V}$	Fig. 5

Thermal Characteristics

Symbol	Parameter	Typ.	Unit	Note
$R_{\theta JC}$	Thermal Resistance from Junction to Case	1.96	$^\circ\text{C/W}$	Fig. 8

Typical Performance

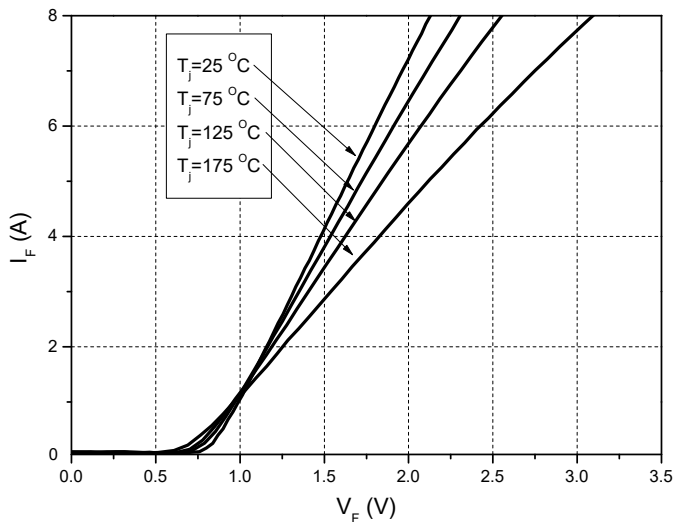

Figure 1. Forward Characteristics

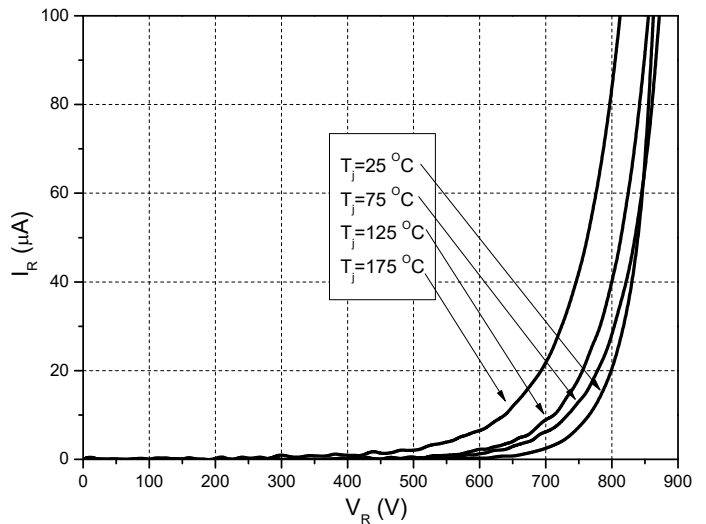

Figure 2. Reverse Characteristics

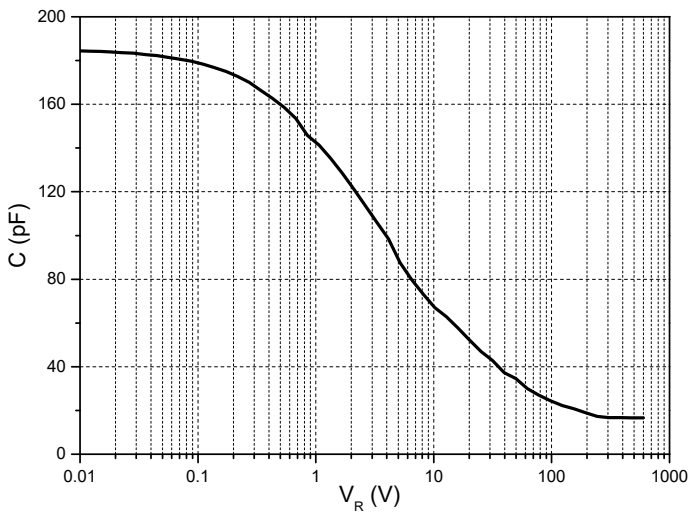

Figure 3. Capacitance vs. Reverse Voltage

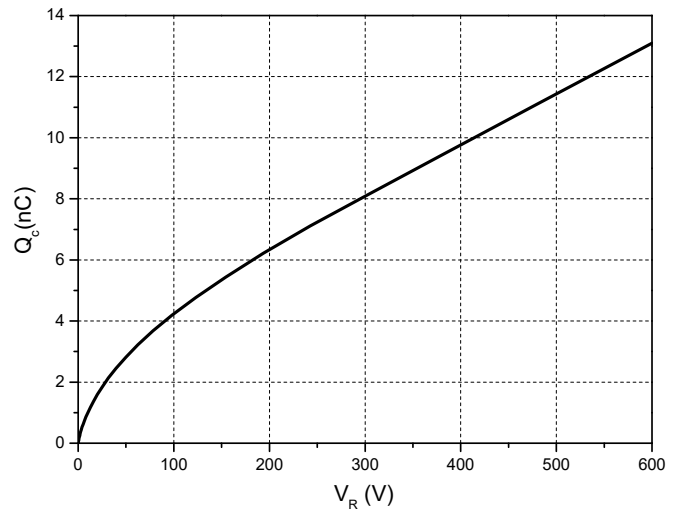

Figure 4. Total Capacitance Charge vs. Reverse Voltage

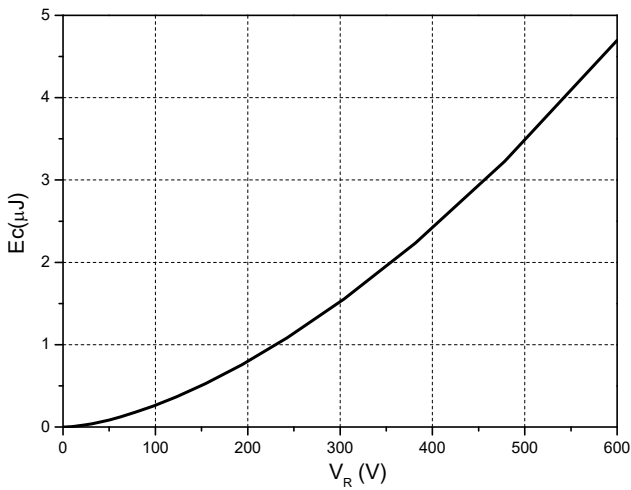

Figure 5. Capacitance Stored Energy

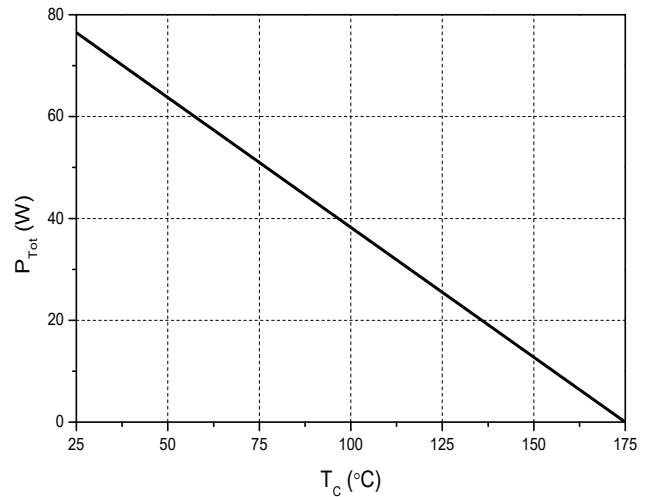

Figure 6. Power Derating

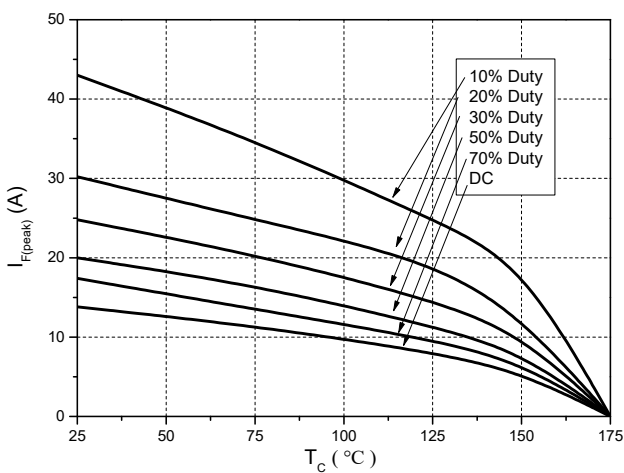

Figure 7. Current Derating

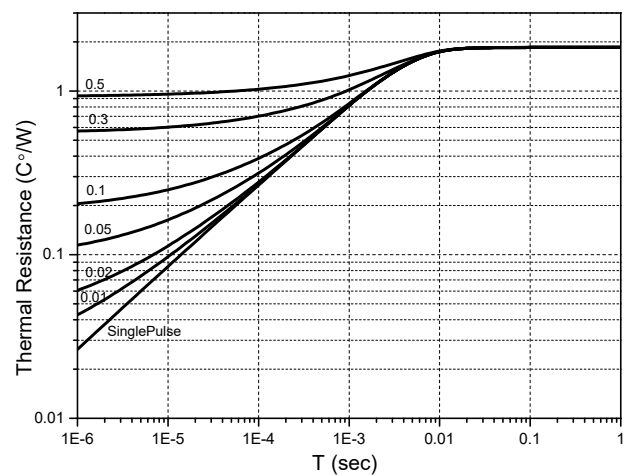
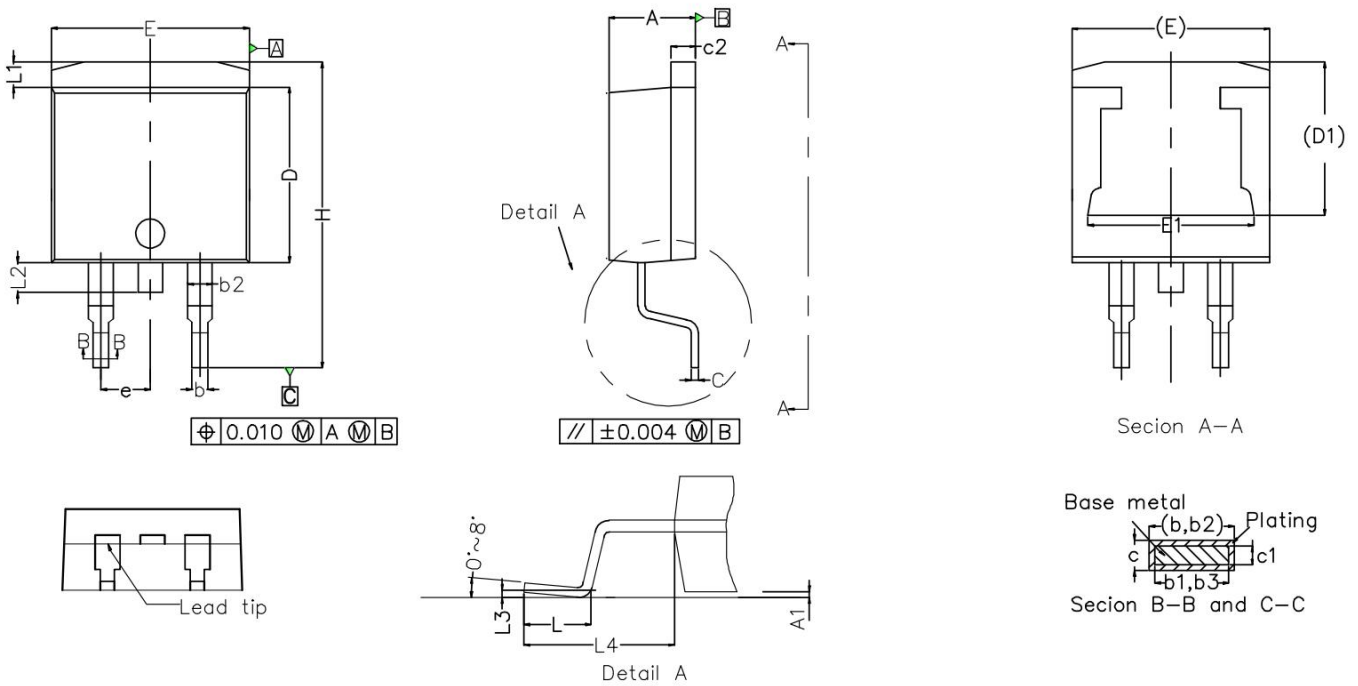

Figure 8. Transient Thermal Impedance

Package Dimensions: TO-263-2L



SYMBOL	MILLIMETERS			NOTES	SYMBOL	MILLIMETERS			NOTES
	Normal	MIN.	MAX.			Normal	MIN.	MAX.	
A	4.55	4.35	4.75		D1	7.75	7.50	8.0	
A1	0.12	0	0.25		E	10.18	10.0	10.4	
b	0.85	0.69	0.94		E1	8.57	8.25	8.80	
b1	0.83	0.69	0.88		e	2.54	2.54BSC		
b2	1.33	1.20	1.45		H	15.20	15.00	15.60	
b3	1.33	1.20	1.45		L	2.64	2.50	2.79	
c	0.50	0.38	0.53		L1	1.35	1.0	1.65	
c1	0.48	0.38	0.56		L2	1.51	1.27	1.78	
c2	1.27	1.14	1.40		L3	0.25	0.25BSC		
D	8.75	8.51	9.02		L4	5.03	4.78	5.28	

NOTES:

- (1) Dimensioning and tolerancing per ASME Y14.5M-1994
- (2) Dimension D and E do not include mold flash. Mold flash shall not exceed 0.127 mm (0.005") per side. These dimensions are measured at the outmost extremes of the plastic body
- (3) Thermal pad contour optional within dimension E, L1, D1 and E1
- (4) Dimension b1 and c1 apply to base metal only
- (5) Datum A and B to be determined at datum plane H
- (6) Controlling dimension; mm
- (7) Outline conforms to JEDEC® outline TO-263AB