

Silicon N-Channel Power MOSFET

General Description :

HMR18N20, the silicon N-channel Enhanced VDMOSFET, is obtained by the self-aligned planar Technology which reduce the conduction loss, improve switching performance and enhance the avalanche energy. The transistor can be used in various power switching circuit for system miniaturization and higher efficiency. The package form is TO-252, which accords with the RoHS standard.

$V_{DSS}(T_C=150^{\circ}C)$	200	V
I_D	18	A
$P_D(T_C=25^{\circ}C)$	156	W
$R_{DS(ON) Typ}$	0.12	Ω

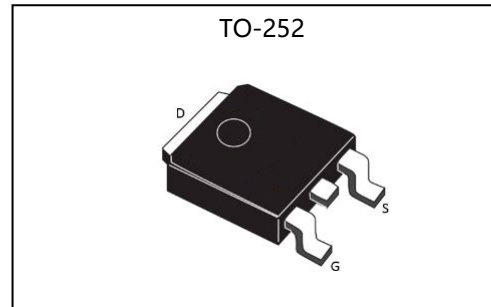

Features :

- Fast Switching
- Low ON Resistance(Typical: 0.12 Ω)
- Low Gate Charge (Typical Data: 24nC)
- Low Reverse transfer capacitances(Typical: 25pF)
- 100% Single Pulse avalanche energy Test

Applications:

- Power switch circuit of PC POWER

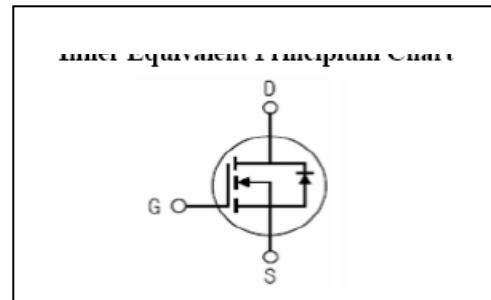

Absolute (Tc=25°C unless otherwise specified) :

Symbol	Parameter	Rating	Units
V_{DSS}	Drain-to-Source Voltage	200	V
I_D	Continuous Drain Current	18	A
	Continuous Drain Current $T_C=100^{\circ}C$	11.2	A
I_{DM}^{a1}	Pulsed Drain Current	72	A
V_{GS}	Gate-to-Source Voltage	± 30	V
E_{AS}	Single Pulse Avalanche Energy	950	mJ
E_{AR}^{a1}	Avalanche Energy ,Repetitive	90	mJ
I_{AR}^{a1}	Avalanche Current	4.2	A
dv/dt^{a3}	Peak Diode Recovery dv/dt	5.0	V/ns
P_D	Power Dissipation	156	W
	Derating Factor above 25°C	1.25	W/°C
T_J, T_{stg}	Operating Junction and Storage Temperature Range	150 , -55 to 150	°C
T_L	MaximumTemperature for Soldering	300	°C

Caution Stresses greater than those in the "Absolute Maximum Ratings" may cause permanent damage to the device

Thermal Characteristics

Symbol	Parameter	Rating	Units
R _{θJC}	Thermal Resistance, Junction-to-Case	0.8	°C/ W
R _{θJA}	Thermal Resistance, Junction-to-Ambient	62.5	°C/ W

Electrical Characteristics (T_c= 25°C unless otherwise specified) :

OFF Characteristics						
Symbol	Parameter	Test Conditions	Rating			Units
			Min.	Typ.	Max.	
V _{DSS}	Drain to Source Breakdown Voltage	V _{GS} =0V, I _D =250μA	200	--	--	V
I _{DSS}	Drain to Source Leakage Current	V _{DS} =200V, V _{GS} =0V, T _a =25°C	--	--	1.0	μA
		V _{DS} =160V, V _{GS} =0V, T _a =125°C	--	--	10	
I _{GSS(F)}	Gate to Source Forward Leakage	V _{GS} =+30V	--	--	100	nA
I _{GSS(R)}	Gate to Source Reverse Leakage	V _{GS} =-30V	--	--	-100	nA

ON Characteristics						
Symbol	Parameter	Test Conditions	Rating			Units
			Min.	Typ.	Max.	
R _{DS(ON)}	Drain-to-Source On-Resistance	V _{GS} =10V, I _D =10.8A	--	0.12	0.18	Ω
V _{GS(TH)}	Gate Threshold Voltage	V _{DS} =V _{GS} , I _D =250μA	2.0	--	4.0	V
g _{fs}	Forward Trans conductance	V _{DS} =15V, I _D =18A	--	18	--	S

Pulse width < 380μs; duty cycle < 2%.

Dynamic Characteristics						
Symbol	Parameter	Test Conditions	Rating			Units
			Min.	Typ.	Max.	
C _{iss}	Input Capacitance	V _{GS} =0V V _{DS} =25V f=1.0MHz	--	1140	--	pF
C _{oss}	Output Capacitance		--	180	--	
C _{rss}	Reverse Transfer Capacitance		--	25	--	

Resistive Switching Characteristics						
Symbol	Parameter	Test Conditions	Rating			Units
			Min.	Typ.	Max.	
t _{d(ON)}	Turn-on Delay Time	I _D =18A, V _{DD} =100V V _{GS} =10V, R _g =2.4Ω	--	11	--	ns
t _r	Rise Time		--	33	--	
t _{d(OFF)}	Turn-Off Delay Time		--	25	--	
t _f	Fall Time		--	7	--	
Q _g	Total Gate Charge	I _D =18A, V _{DD} =100V V _{GS} =10V	--	24	--	nC
Q _{gs}	Gate to Source Charge		--	7.5	--	
Q _{gd}	Gate to Drain ("Miller") Charge		--	9.5	--	

Source-Drain Diode Characteristics						
Symbol	Parameter	Test Conditions	Rating			Units
			Min.	Typ.	Max.	
I_{SD}	Continuous Source Current (Body Diode)		--	--	18	A
I_{SM}	Maximum Pulsed Current (Body Diode)		--	--	72	A
V_{SD}	Diode Forward Voltage	$I_S=18A, V_{GS}=0V$	--	--	1.5	V
t_{rr}	Reverse Recovery Time	$I_S=18A, T_j=25^\circ C$	--	160	--	ns
Q_{rr}	Reverse Recovery Charge	$dI_F/dt=100A/\mu s, V_{GS}=0V$	--	880	--	μC

a1 : Repetitive rating; pulse width limited by maximum junction temperature

a2 : $L=10.0mH, I_D=13.8A, \text{Start } T_J=25^\circ C$

a3 : $I_{SD}=18A, di/dt \leq 100A/\mu s, V_{DD} \leq BV_{DS}, \text{Start } T_J=25^\circ C$

Characteristics Curve :

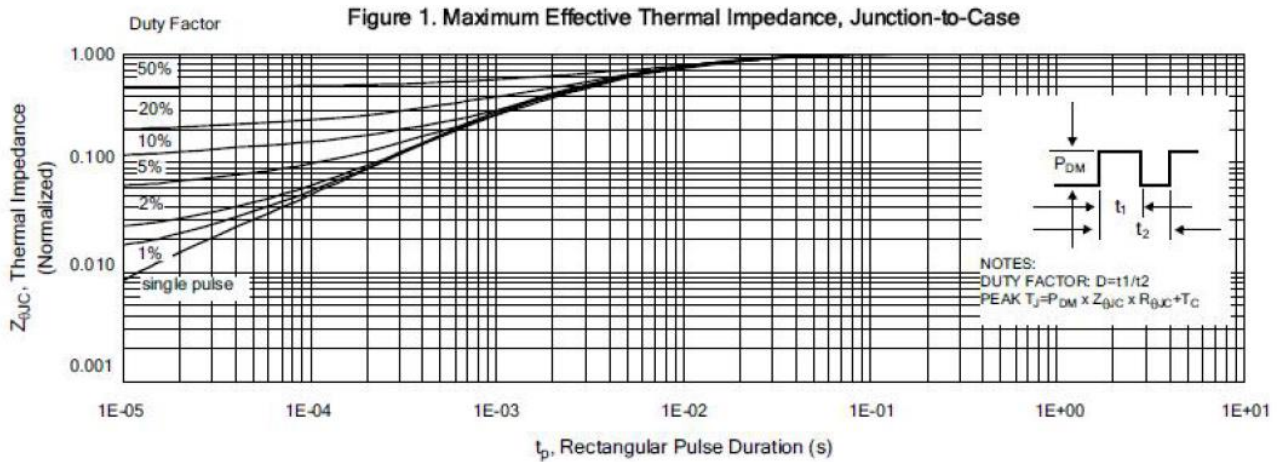

Figure 2. Maximum Power Dissipation vs Case Temperature

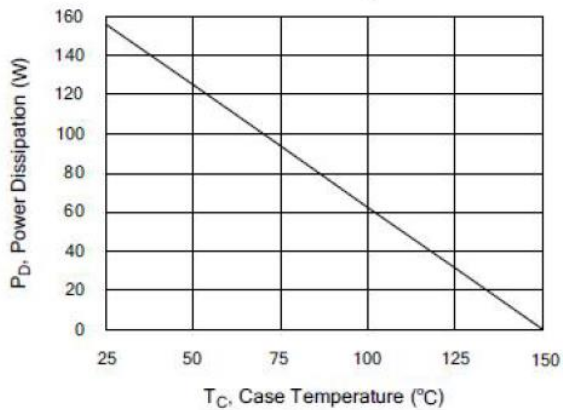

Figure 3. Maximum Continuous Drain Current vs Case Temperature

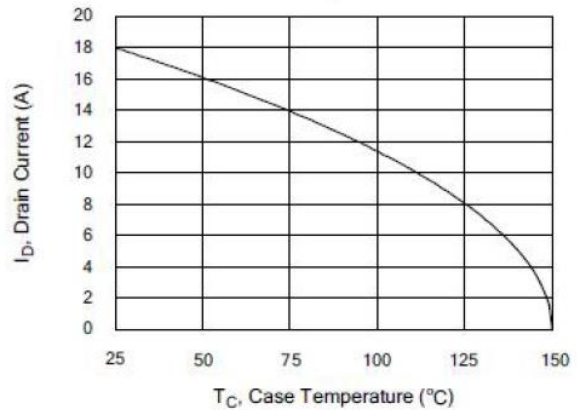

Figure 4. Typical Output Characteristics

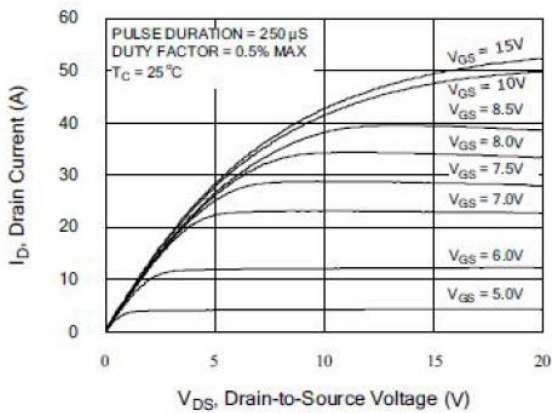

Figure 5. Typical Drain-to-Source ON Resistance vs Gate Voltage and Drain Current

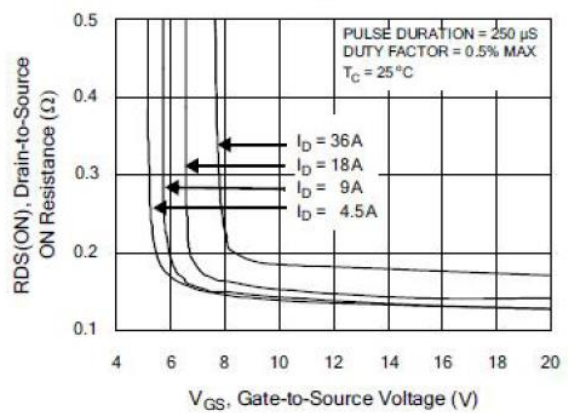

Figure 6. Maximum Peak Current Capability

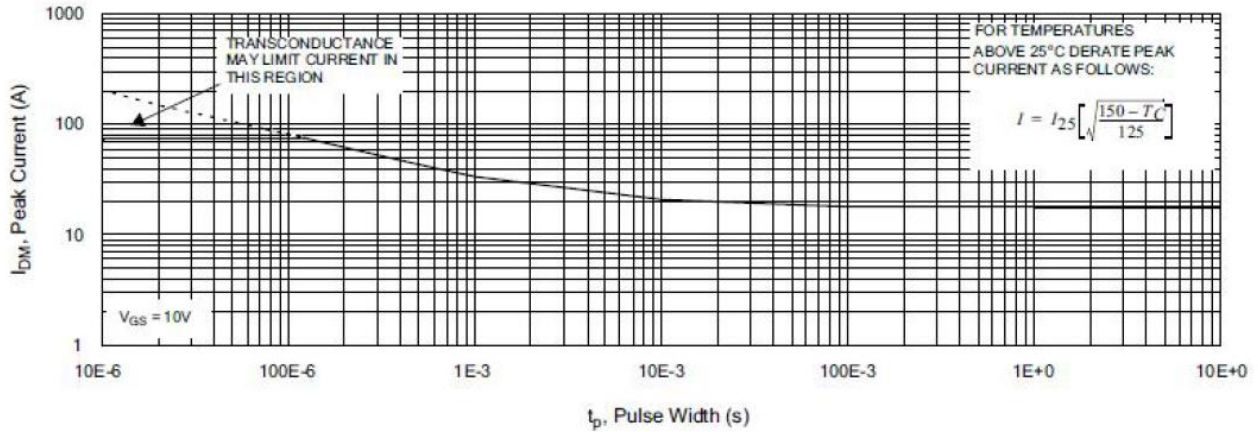

Figure 7. Typical Transfer Characteristics

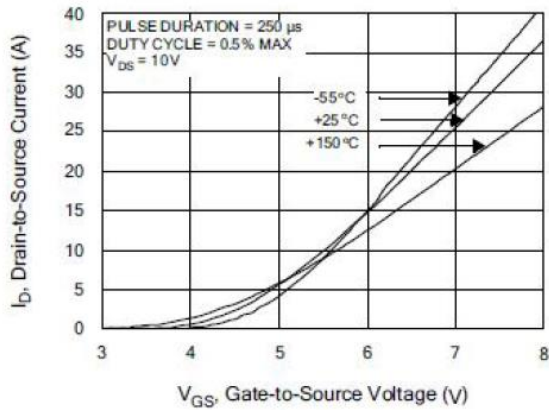

Figure 8. Unclamped Inductive Switching Capability

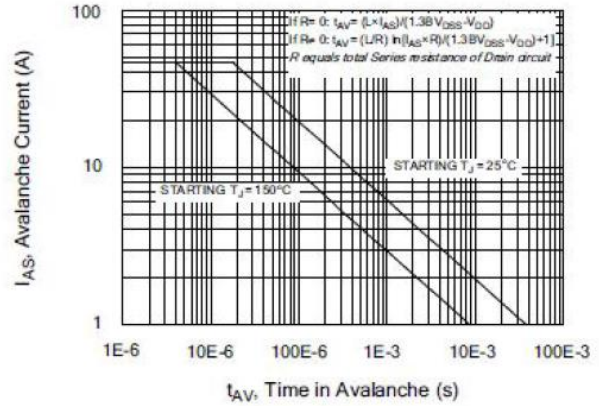

Figure 9. Typical Drain-to-Source ON Resistance vs Drain Current

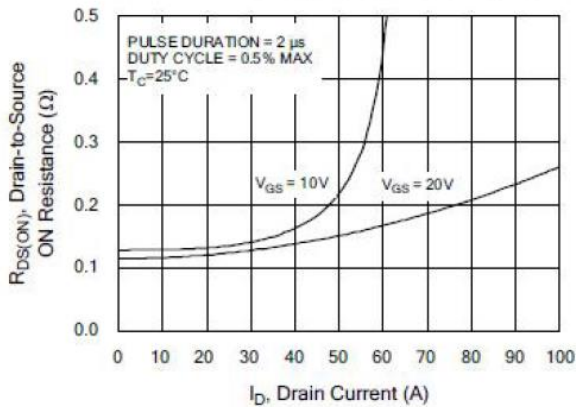

Figure 10. Typical Drain-to-Source ON Resistance vs Junction Temperature

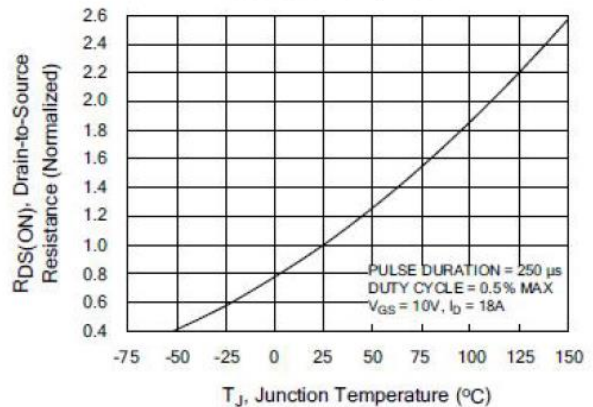

Figure 11. Typical Breakdown Voltage vs Junction Temperature

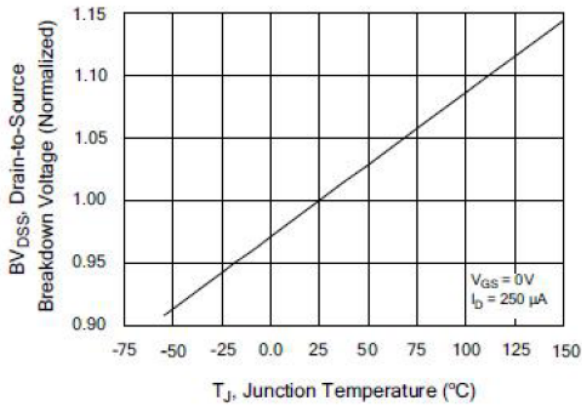

Figure 12. Typical Threshold Voltage vs Junction Temperature

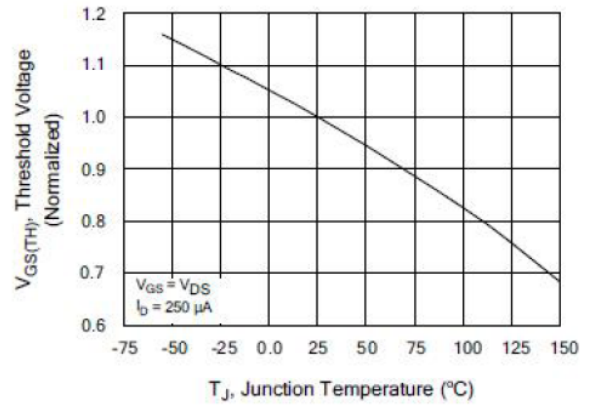

Figure 13. Maximum Forward Bias Safe Operating Area

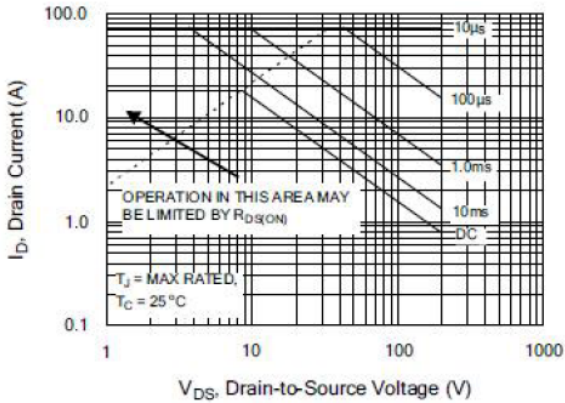

Figure 14. Typical Capacitance vs Drain-to-Source Voltage

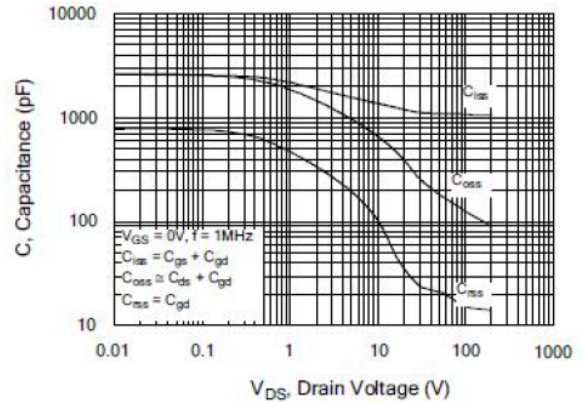

Figure 15. Typical Gate Charge vs Gate-to-Source Voltage

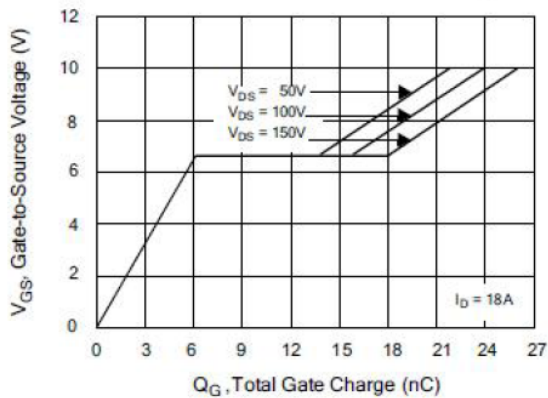

Figure 16. Typical Body Diode Transfer Characteristics

