

Silicon N-Channel Power MOSFET

General Description :

HMB30N50, the silicon N-channel Enhanced VDMOSFET, is obtained by the self-aligned planar Technology which reduce the conduction loss, improve switching performance and enhance the avalanche energy. The transistor can be used in various power switching circuit for system miniaturization and higher efficiency. The package form is TO-220AB, which accords with the RoHS standard.

Features :

- Fast Switching
- Low ON Resistance(Typical Data:0.170Ω)
- Low Gate Charge Minimize Switching loss
- Fast Recovery Body Diode
- 100% Single Pulse avalanche energy Test

Applications:

- Adaptor
- Charger
- SMPS Standby Power

Absolute (Tc=25°C unless otherwise specified) :

Symbol	Parameter	Rating	Units
V _{DSS}	Drain-to-Source Voltage*1	500	V
I _D	Continuous Drain Current	30	A
I _{DM}	Pulsed Drain Current at V _{GS} =10V*2	120	A
V _{GS}	Gate-to-Source Voltage	± 30	V
E _{AS}	Single Pulse Avalanche Energy	1800	mJ
I _{AS}	Avalanche Current	8.8	A
dv/dt	Peak Diode Recovery dv/dt*3	5.0	V/ns
P _D	Power Dissipation	312.5	W
	Derating Factor above 25°C	2.5	W/°C
T _J , T _{stg}	Operating Junction and Storage Temperature Range	150,-55 to 150	°C
T _L	Maximum Temperature for Soldering	300	°C

Caution Stresses greater than those in the "Absolute Maximum Ratings" may cause permanent damage to the devic

V _{DSS} (T _c =150°C)	500	V
I _D	30	A
P _D (T _c =25°C)	312.5	W
R _{DS(ON).type.}	170	mΩ

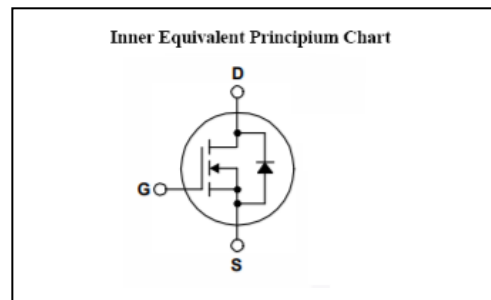
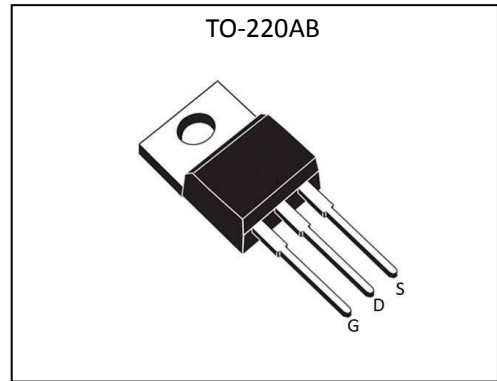

Thermal Characteristics

Symbol	Parameter	Rating	Units
$R_{\theta JC}$	Thermal Resistance, Junction-to-Case	0.4	°C/ W
$R_{\theta JA}$	Thermal Resistance, Junction-to-Ambient	62.5	°C/ W

Electrical Characteristics ($T_c = 25^\circ\text{C}$ unless otherwise specified) :

OFF Characteristics						
Symbol	Parameter	Test Conditions	Rating			Units
			Min.	Typ.	Max.	
V_{DSS}	Drain to Source Breakdown Voltage	$V_{GS}=0V, I_D=250\mu A$	500	--	--	V
I_{DSS}	Drain to Source Leakage Current	$V_{DS}=500V, V_{GS}=0V, T_a=25^\circ\text{C}$	--	--	1.0	μA
		$V_{DS}=400V, V_{GS}=0V, T_a=125^\circ\text{C}$	--	--	100	
$I_{GSS(F)}$	Gate to Source Forward Leakage	$V_{GS}=+30V$	--	--	100	nA
$I_{GSS(R)}$	Gate to Source Reverse Leakage	$V_{GS}=-30V$	--	--	-100	nA

ON Characteristics						
Symbol	Parameter	Test Conditions	Rating			Units
			Min.	Typ.	Max.	
$R_{DS(ON)}$	Drain-to-Source On-Resistance*4	$V_{GS}=10V, I_D=15.0\text{ A}$	--	170	200	m Ω
$V_{GS(TH)}$	Gate Threshold Voltage	$V_{DS}=V_{GS}, I_D=250\mu A$	2.0	--	4.0	V
g_{fs}	Forward Transconductance*4	$V_{DS}=15V, I_D=15A$	--	17	--	S

Dynamic Characteristics						
Symbol	Parameter	Test Conditions	Rating			Units
			Min.	Typ.	Max.	
C_{iss}	Input Capacitance	$V_{GS}=0V, V_{DS}=25V$ $f=1.0\text{MHz}$	--	4650	--	pF
C_{oss}	Output Capacitance		--	410	--	
C_{rss}	Reverse Transfer Capacitance		--	40	--	

Resistive Switching Characteristics						
Symbol	Parameter	Test Conditions	Rating			Units
			Min.	Typ.	Max.	
$t_{d(ON)}$	Turn-on Delay Time	$I_D=30A, V_{DD}=250V$ $V_{GS}=10V, R_g=25\Omega$	--	50	--	ns
t_r	Rise Time		--	115	--	
$t_{d(OFF)}$	Turn-Off Delay Time		--	301	--	
t_f	Fall Time		--	125	--	
Q_g	Total Gate Charge	$I_D=30A, V_{DD}=250V$ $V_{GS}=10V$	--	88	--	nC
Q_{gs}	Gate to Source Charge		--	15	--	
Q_{gd}	Gate to Drain ("Miller") Charge		--	40	--	

Source-Drain Diode Characteristics				
Symbol	Parameter	Test Conditions	Rating	Units

			Min.	Typ.	Max.	
I_{SD}	Continuous Source Current (Body Diode)		--	--	30	A
I_{SM}	Maximum Pulsed Current (Body Diode)		--	--	120	A
V_{SD}	Diode Forward Voltage	$I_S=30A, V_{GS}=0V$	--	--	1.5	V
t_{rr}	Reverse Recovery Time	$I_S=30A, T_j=25^\circ C$	--	550	--	ns
Q_{rr}	Reverse Recovery Charge	$dI_F/dt=100A/\mu s, V_{GS}=0V$	--	5.46	--	μC

*1: $T_j = +25^\circ C$ to $+150^\circ C$

*2: Repetitive rating; pulse width limited by maximum junction temperature.

*3: $I_{SD}=30A, di/dt < 100A/\mu s, V_{DD} < BV_{DSS}, T_j = +150^\circ C$.

*4: Pulse width $< 380\mu s$; duty cycle $< 2\%$.

Characteristics Curve :

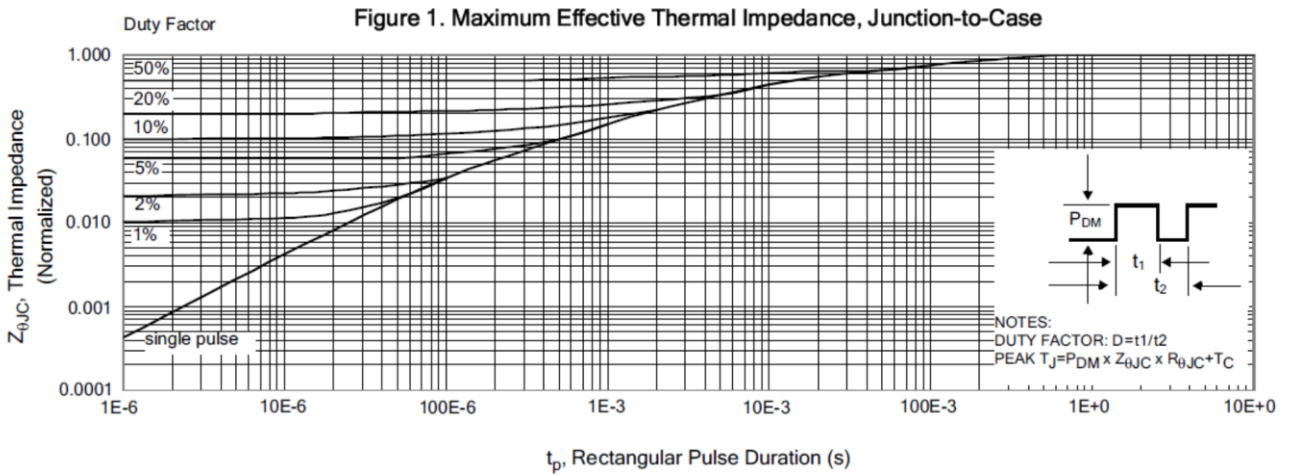

Figure 2. Maximum Power Dissipation vs Case Temperature

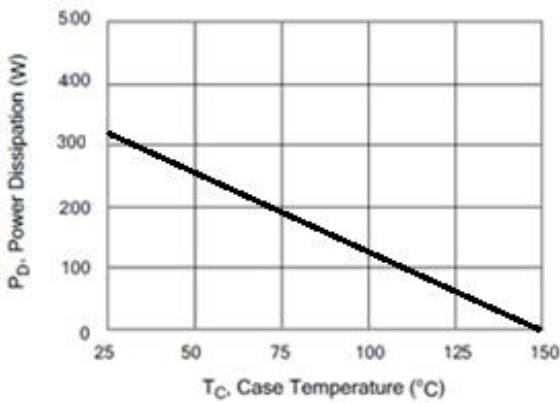

Figure 3. Maximum Continuous Drain Current vs Case Temperature

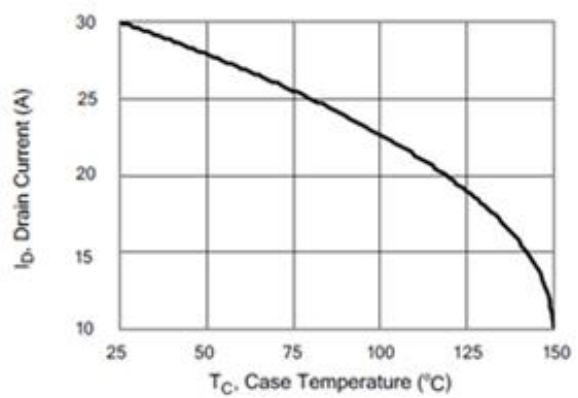

Figure 4. Typical Output Characteristics

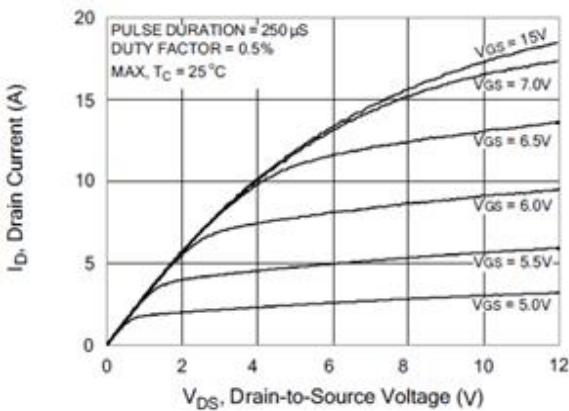

Figure 5. Typical Drain-to-Source ON Resistance vs Gate Voltage and Drain Current

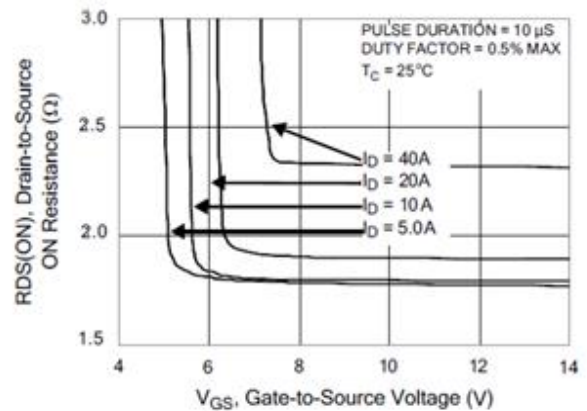

Figure 6. Maximum Peak Current Capability

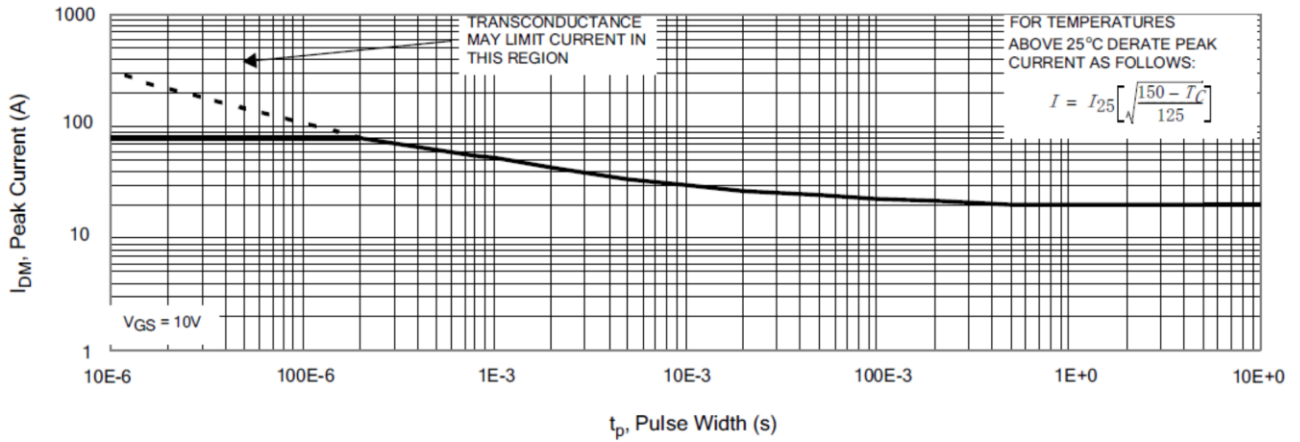

Figure 7. Typical Transfer Characteristics

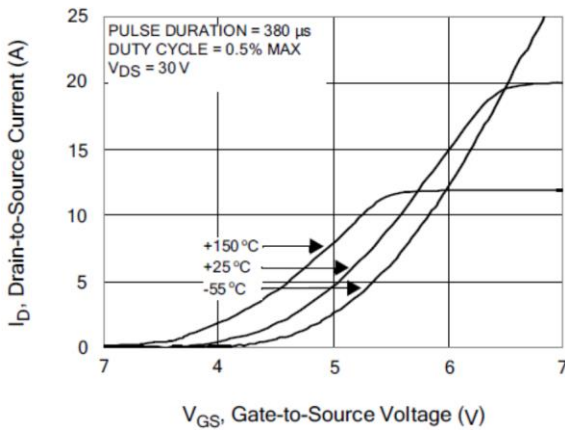

Figure 9. Typical Drain-to-Source ON Resistance vs Drain Current

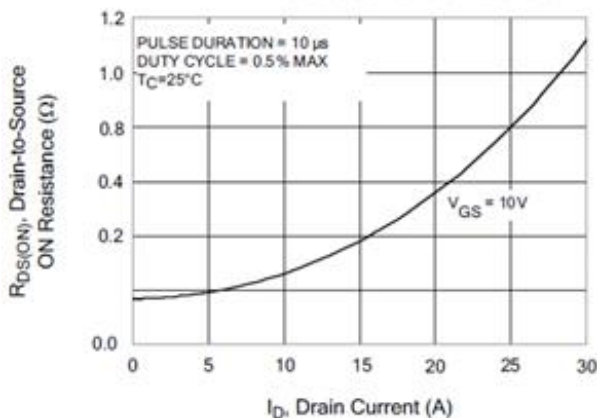

Figure 8. Unclamped Inductive Switching Capability

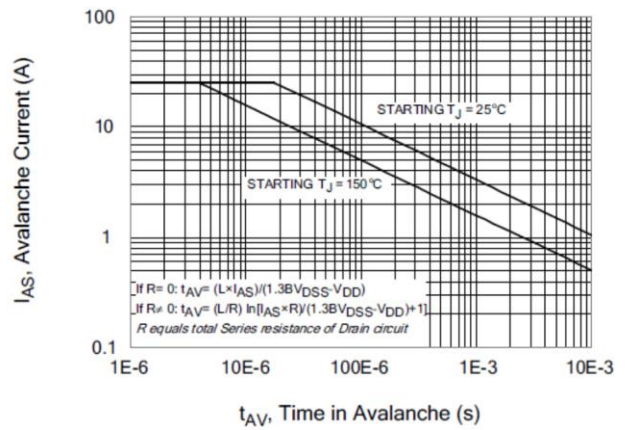

Figure 10. Typical Drain-to-Source ON Resistance vs Junction Temperature

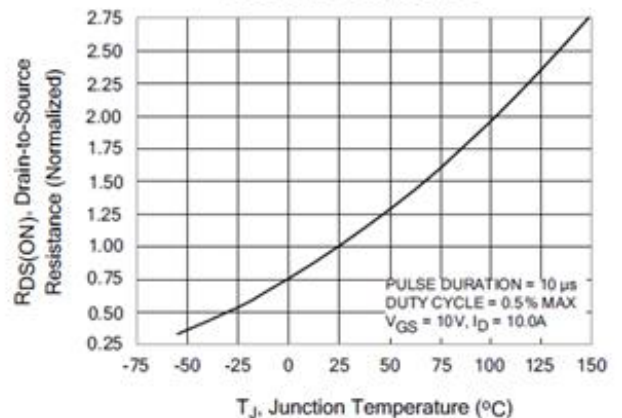

Figure 11. Typical Breakdown Voltage vs Junction Temperature

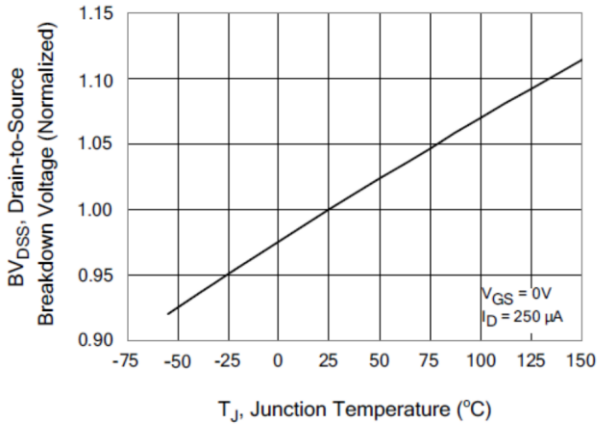

Figure 12. Typical Threshold Voltage vs Junction Temperature

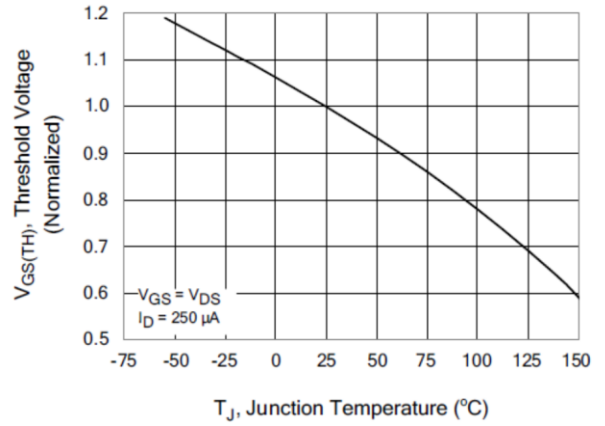

Figure 13. Maximum Forward Bias Safe Operating Area

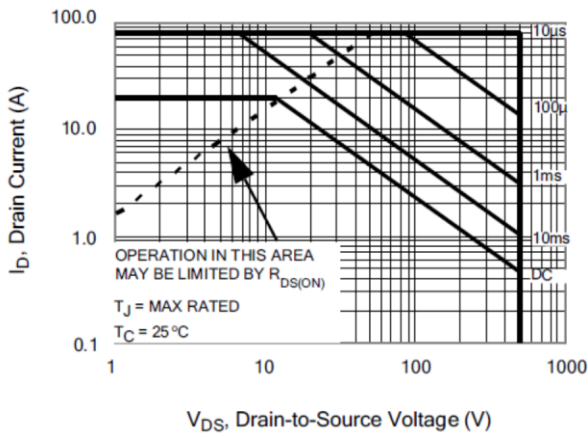

Figure 14. Typical Capacitance vs Drain-to-Source Voltage

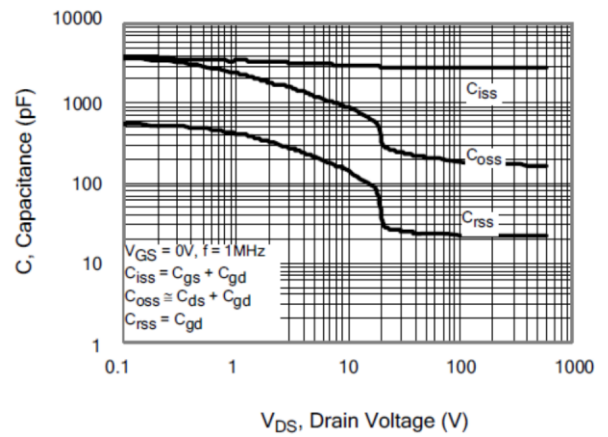

Figure 15. Typical Gate Charge vs Gate-to-Source Voltage

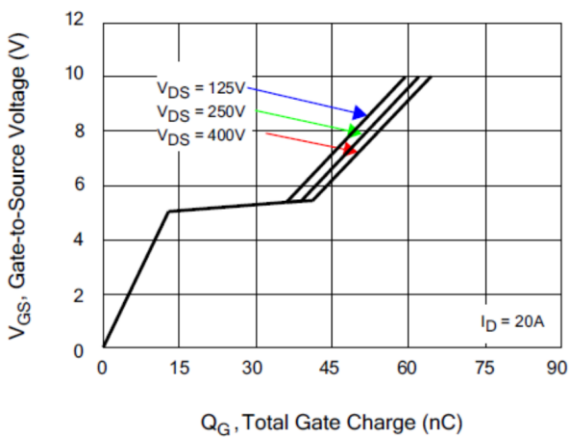

Figure 16. Typical Body Diode Transfer Characteristics

