

FEATURES

- High breakdown voltage to 1200V for improved reliability
- Trench-Stop Technology offering :
 - very tight parameter distribution
 - high ruggedness, temperature stable behavior
 - Short circuit withstand time – 10μs
 - High ruggedness, temperature stable
 - Low $V_{CE(SAT)}$
 - Easy parallel switching capability due to positive temperature coefficient in $V_{CE(SAT)}$
- Enhanced avalanche capability

V_{CE}	1200	V
I_C	10	A
$V_{CE(SAT)} I_C=10A$	1.60	V

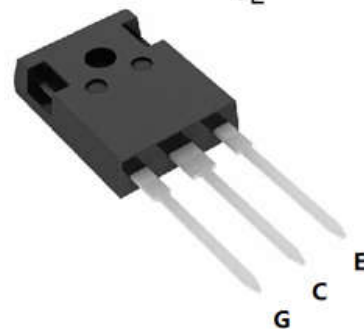
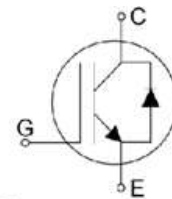

APPLICATION

- Frequency Converters
- Motor Drive

Product	Package	Packaging
HG10N120T1	TO247	Tube

Maximum Ratings

Parameter	Symbol	Value	Unit
Collector-Emitter Breakdown Voltage	V_{CE}	1200	V
DC collector current, limited by T_{jmax} $T_C = 25^\circ C$ $T_C = 100^\circ C$	I_C	20 10	A
Diode Forward current, limited by T_{jmax} $T_C = 25^\circ C$ $T_C = 100^\circ C$	I_F	20 10	A
Continuous Gate-emitter voltage	V_{GE}	± 20	V
Transient Gate-emitter voltage	V_{GE}	± 30	V
Turn off safe operating area $V_{CE} \leq 1200V$, $T_j \leq 150^\circ C$	-	40	A
Pulsed collector current, $V_{GE} = 15V$, t_p limited by T_{jmax}	I_{CM}	40	A
Short Circuit Withstand Time, $V_{GE} = 15V$, $V_{CE} \leq 600V$	T_{sc}	10	μs
Power dissipation , $T_j = 25^\circ C$	P_{tot}	260	W
Operating junction temperature	T_j	-40...+150	$^\circ C$
Storage temperature	T_s	-55...+150	$^\circ C$
Soldering temperature, wave soldering 1.6mm (0.063in.) from case for 10s	-	260	$^\circ C$

Thermal Resistance

Parameter	Symbol	Max. Value	Unit
IGBT thermal resistance, junction - case	$R_{\theta(j-c)}$	0.69	K/W
Diode thermal resistance, junction - case	$R_{\theta(j-c)}$	1.5	K/W
Thermal resistance, junction - ambient	$R_{\theta(j-a)}$	40	K/W

Electrical Characteristics of the IGBT ($T_j = 25^\circ\text{C}$ unless otherwise specified) :

Parameter	Symbol	Conditions	Min	Typ	Max	Unit
Static						
Collector-Emitter breakdown voltage	BV_{CES}	$V_{GE}=0V, I_C=250\mu A$	1200	-	-	V
Gate threshold voltage	$V_{GE(th)}$	$V_{GE}=V_{CE}, I_C=250\mu A$	5.2	5.8	6.8	V
Collector-Emitter Saturation voltage	$V_{CE(sat)}$	$V_{GE}=15V, I_C=10A$ $T_j = 25^\circ\text{C}$ $T_j = 150^\circ\text{C}$	- -	1.60 1.95	1.95 -	V
Zero gate voltage collector current	I_{CES}	$V_{CE} = 1200V, V_{GE} = 0V$ $T_j = 25^\circ\text{C}$ $T_j = 150^\circ\text{C}$	- -	- -	100 1000	μA
Gate-emitter leakage current	I_{GES}	$V_{CE} = 0V, V_{GE} = \pm 20V$	-	-	100	nA
Transconductance	gfs	$V_{CE} = 20V, I_C = 10A$	-	10	-	S

Parameter	Symbol	Conditions	Min	Typ	Max	Unit
Dynamic						
Input capacitance	C_{ies}	$V_{CE} = 25V, V_{GE} = 0V,$ $f = 1\text{MHz}$	-	1510	-	pF
Output capacitance	C_{oes}		-	50	-	
Reverse transfer capacitance	C_{res}		-	18	-	
Gate charge	Q_G	$V_{CC} = 960V, I_C = 15A,$ $V_{GE} = 15V$	-	84	-	nC

Switching Characteristic, Inductive Load

Parameter	Symbol	Conditions	Min	Typ	Max	Unit
Dynamic , at $T_j = 25^\circ \text{C}$						
Turn-on delay Time	$t_{d(on)}$	$V_{CC} = 600\text{V}$, $I_C = 10\text{A}$, $V_{GE} = 0/15\text{V}$, $R_g = 12\Omega$	-	22	-	ns
Rise Time	t_r		-	15	-	ns
Turn-off delay time	$t_{d(off)}$		-	70	-	ns
Fall time	t_f		-	77	-	ns
Turn-on Energy	E_{on}		-	1.20	-	mJ
Turn-off energy	E_{off}		-	0.17	-	mJ

Electrical Characteristics of the DIODE ($T_j = 25^\circ \text{C}$ unless otherwise specified)

Parameter	Symbol	Conditions	Min	Typ	Max	Unit
Dynamic						
Diode Forward Voltage	V_{FM}	$I_F = 10\text{A}$	-	2.3	-	V
Reverse Recovery Time	T_{rr}	$I_F = 15\text{A}$, $di/dt = 600\text{A}/\mu\text{s}$	-	270	-	ns
Reverse Recovery Current	I_{rr}		-	10	-	A
Reverse Recovery Charge	Q_{rr}		-	1800	-	nC

Fig. 1 FBSOA characteristics

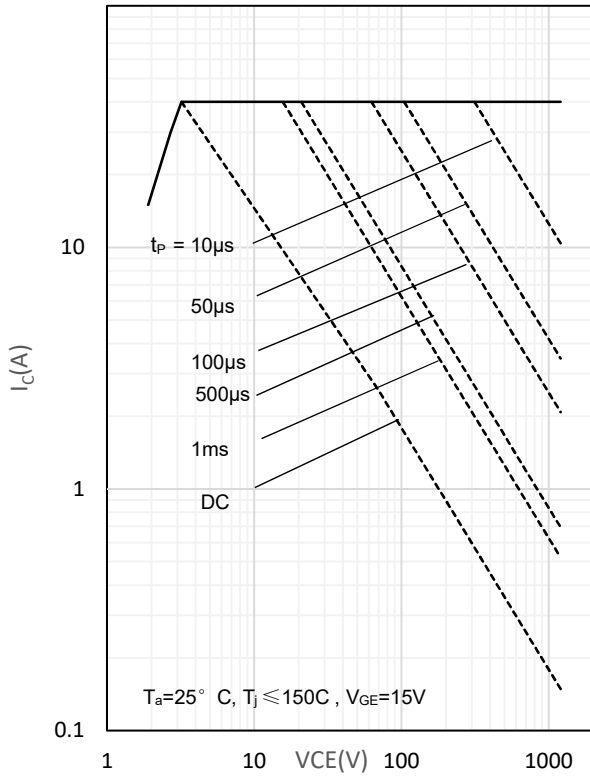

Fig. 2 Load Current vs. Frequency

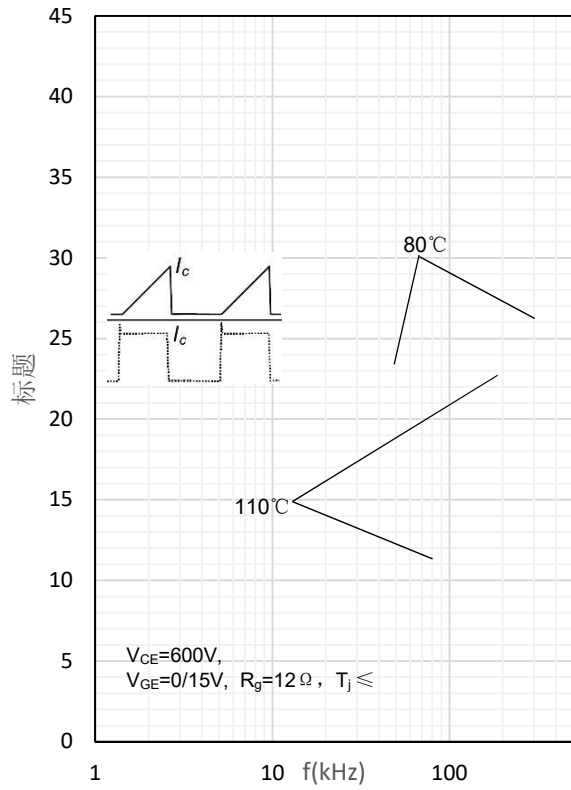

Fig. 3 Output characteristics

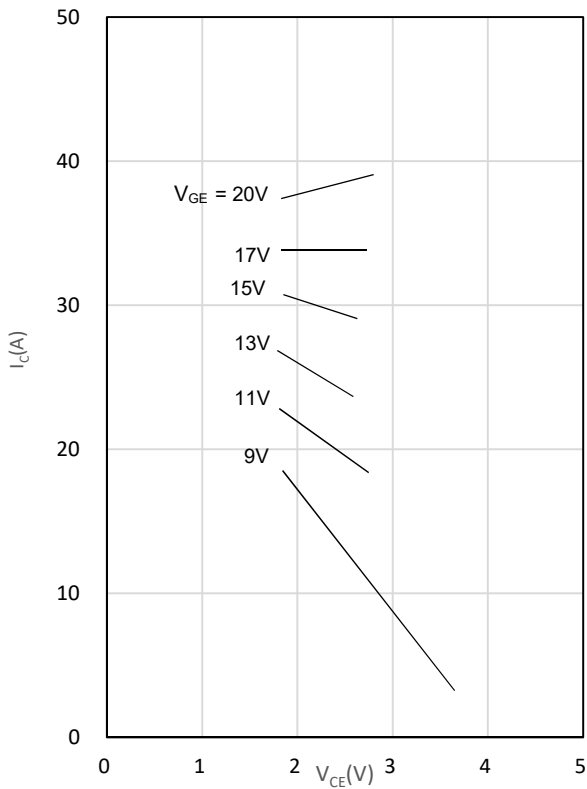

Fig. 4 Saturation voltage characteristics

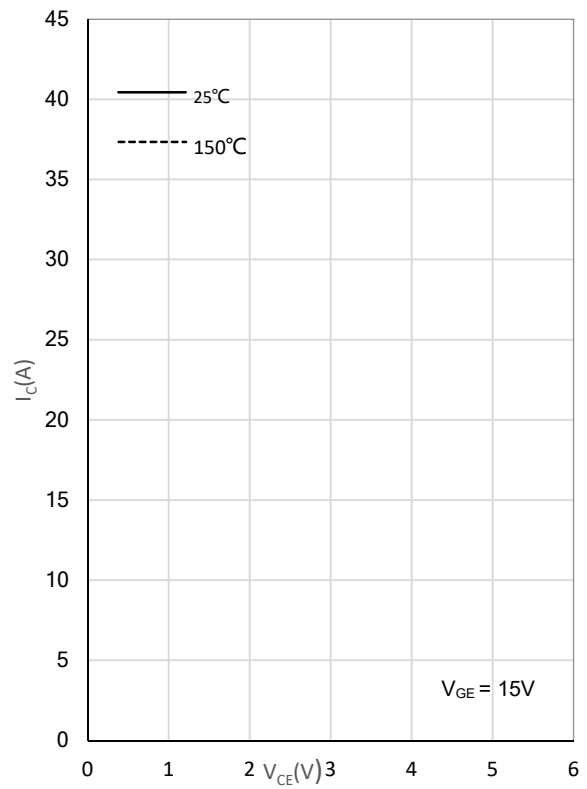

Fig. 5 Switching times vs. gate resistor

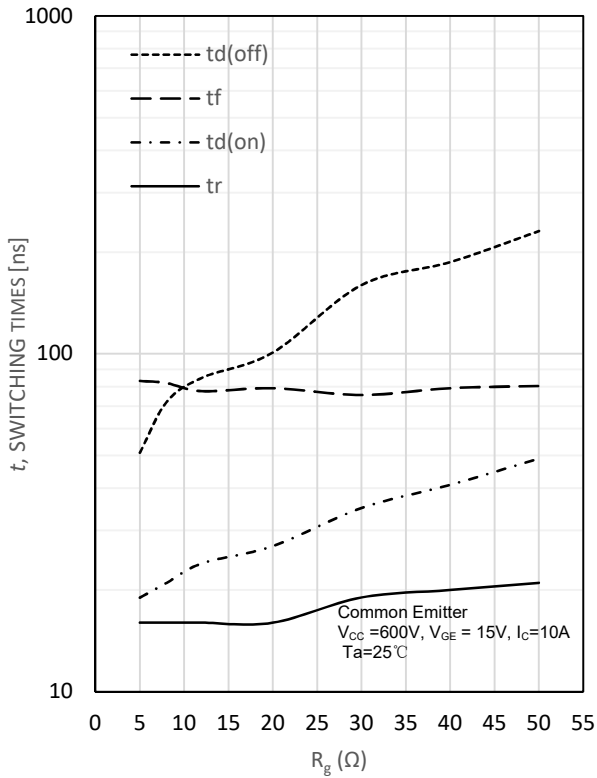

Fig. 6 Switching times vs. collector current

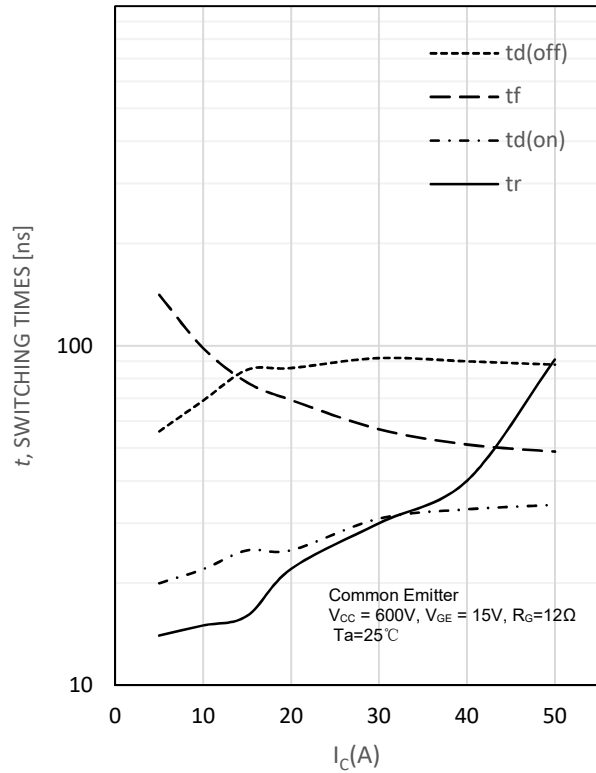

Fig. 7 Switching loss vs. gate resistor

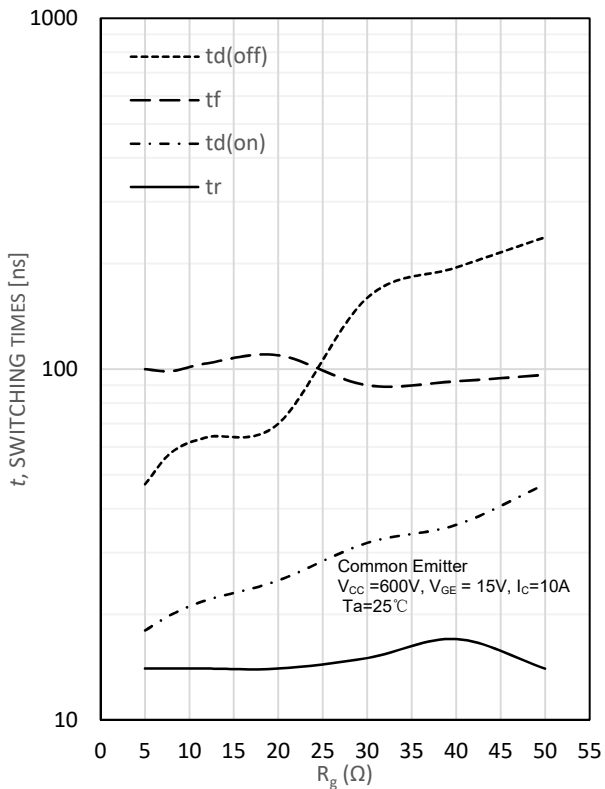

Fig. 8 Switching loss vs. collector current

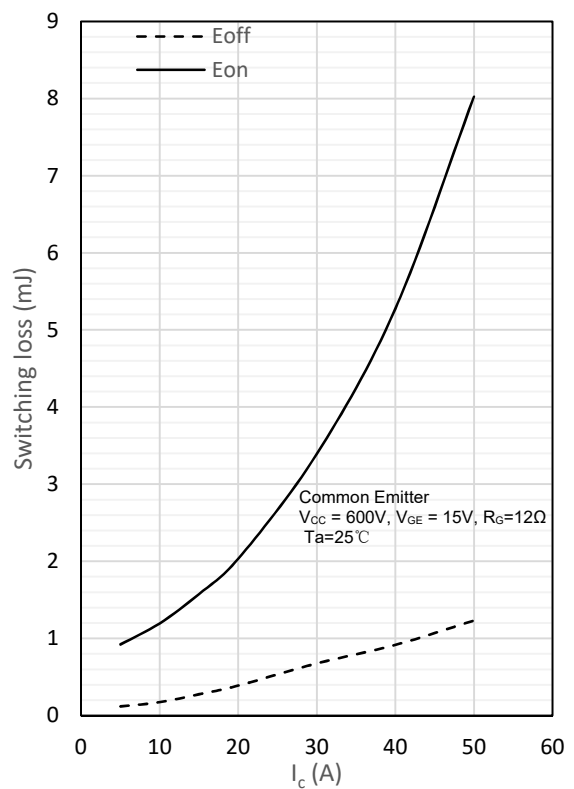

Fig. 9 Gate charge characteristics

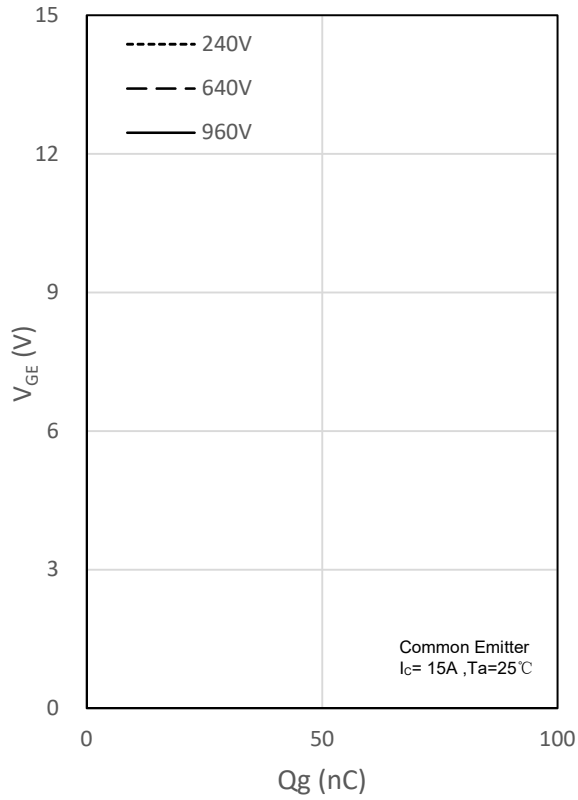
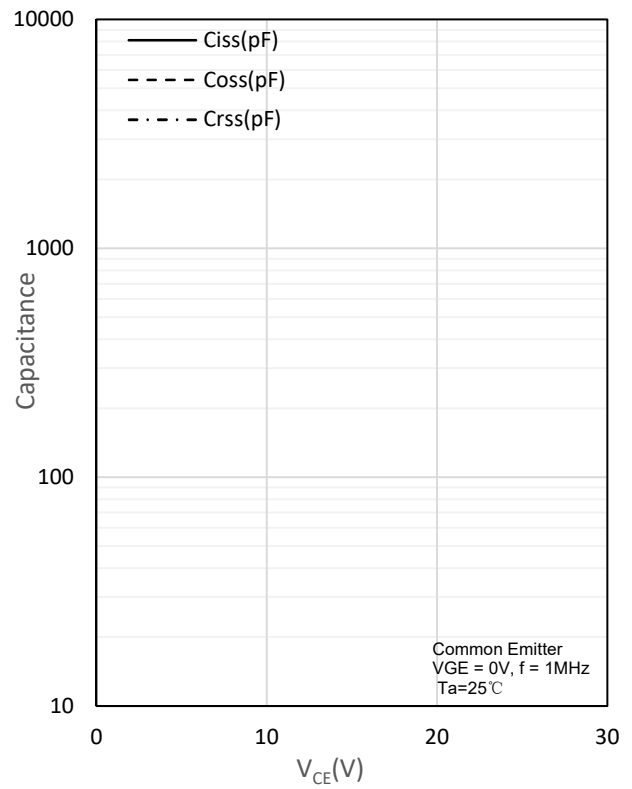

Fig. 10 Capacitance characteristics



PG-TO247-3

