



H1M45170K

Product Summary

1700V, 45mΩ, TO-247-4L SiC MOSFET

V_{DS}	1700V
$I_D(@25^{\circ}C)$	55A
$R_{DS(on)}$	45mΩ

Features

- Low On-Resistance and High Current Density
- Low Capacitance for High Frequency Operation
- Ultra-high Avalanche Ruggedness
- Positive Temperature Coefficient Device
- AEC-Q101 Qualified
- RoHS Compliant and Halogen Free

Benefits

- Higher System Efficiency
- Increase Parallel Device Convenience
- Capable of 175°C High T_j Application
- Allow High Frequency Operation
- Realize Compact and Lightweight Systems

Applications

- Switching Mode Power Supply
- DC/DC Converters, UPS, and PFC
- Power Inverters
- Auxiliary Power Supplies
- Solar/Wind Renewable Energy

Circuit Diagram

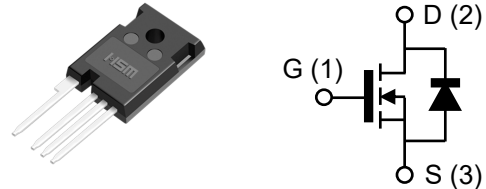

Part Number	Package	Marking
H1M45170K	TO-247-4L	H1M45170K

Description

The H1M045170P 1700V, 45mΩ silicon carbide power MOSFET is an N-channel enhancement mode device. Exploiting the outstanding wide bandgap material properties, this device shows high current density and great switching behavior. Thanks for the excellent thermal conductivity and many advantages of SiC, this device significantly improved in thermal capability and temperature independent switching behavior. With the high stability and reliability, this device also passes the qualification criteria based on AEC-Q101.

Absolute Maximum Ratings ($T_c = 25^{\circ}C$ unless otherwise specified)

Parameter	Symbol	Test Conditions	Value	Unit
Drain – Source Voltage	$V_{DS,max}$	$V_{GS}=0V, I_{DS}=100\mu A$	1700	V
Continuous Drain Current	I_D	$V_{GS}=20V, T_c=25^{\circ}C$	55	A
		$V_{GS}=20V, T_c=110^{\circ}C$	38.5	
Pulse Drain Current	$I_{D,pulse}$	t_{PW} limitation per Fig.15	280	
Power Dissipation	P_D	$T_c=25^{\circ}C$	375	W
Recommend Gate Source Voltage	$V_{GS,op}$	Static, recommended DC operating values	-5/+20	V
Maximum Gate Source Voltage	$V_{GS,max}$	Transient operating limit (AC $f > 1Hz$, duty cycle $< 1\%$)	-10/+25	
Junction & Storage Temperature	T_j, T_{stg}		-55/+175	$^{\circ}C$
Soldering Temperature	T_L		260	
Mounting Torque	M_D	M3 or 6-32 screw	1.0	Nm

Thermal Resistance

Parameter	Symbol	Min.	Typ.	Max.	Unit
Thermal Resistance, Junction to Case	$R_{\theta,jc}$		0.4		$^{\circ}C/W$

Electrical Characteristics ($T_c = 25^\circ\text{C}$ unless otherwise specified)

Parameter	Symbol	Test Conditions	Min.	Typ.	Max.	Unit
Drain-Source Breakdown Voltage	$V_{(BR)DSS}$	$V_{GS}=0V, I_{DS}=100\mu A$	1700			V
Gate Threshold Voltage	$V_{GS(th)}$	$V_{DS}=10V, I_{DS}=50mA$		2.6		V
Zero Gate Voltage Drain Current	I_{DSS}	$V_{DS}=1700V, V_{GS}=0V$		<1	100	μA
		$V_{DS}=1700V, V_{GS}=0V$ $T_j=175^\circ\text{C}$		10	500	
Gate-Source Leakage Current	I_{GSS}	$V_{GS}=20V, V_{DS}=0V$			250	nA
Drain-Source On-State Resistance	$R_{DS(on)}$	$V_{GS}=20V, I_{DS}=30A$		45	70	m Ω
		$V_{GS}=20V, I_{DS}=30A$, $T_j=175^\circ\text{C}$		100		
Transconductance	g_{fs}	$V_{DS}=8.5V, I_{DS}=30A$		16		S
Input Capacitance	C_{iss}	$V_{GS}=0V, V_{DS}=1000V$ $f=1MHz, V_{AC}=25mV$		4141		pF
Output Capacitance	C_{oss}			145		
Reverse Transfer Capacitance	C_{rss}			25		
Effective Output Capacitance, Energy Related	$C_{o(er)}$	$V_{GS}=0V$, $V_{DS}=0$ to 1000V		187		pF
Effective Output Capacitance, Time Related	$C_{o(tr)}$	$I_D=const.$, $V_{GS}=0V$, $V_{DS}=0$ to 1000V		253		
Turn On Delay Time	$t_{d(on)}$	$V_{DS}=1200V, V_{GS}=-4/20V$, $I_D=30A, R_L=1200\Omega$, $R_{G(ext)}=2.7\Omega$		51		ns
Rise Time	t_r			53		
Turn Off Delay Time	$t_{d(off)}$			59		
Fall Time	t_f			22		
C_{oss} Stored Energy	E_{oss}	$V_{GS}=0V, V_{DS}=1200V$ $f=1MHz, V_{AC}=25mV$		119		μJ
Turn-on Switching Energy	E_{on}	$V_{DS}=1200V, V_{GS}=0/20V$, $I_D=30A$,		194*		
Turn-off Switching Energy	E_{off}	$R_{G(ext)}=2.7\Omega$		326*		
Internal Gate Resistance	$R_{G(int.)}$	$f=1MHz, V_{AC}=25mV$		0.7		Ω

*Based on the results of calculation, note that the energy loss caused by the reverse recovery of free-wheeling diode is not included in E_{on} .

Built-in SiC Diode Characteristics ($T_c = 25^\circ\text{C}$ unless otherwise specified)

Parameter	Symbol	Test Conditions	Typ.	Unit
Inverse Diode Forward Voltage	V_{SD}	$V_{GS}=0V, I_{SD}=7.5A$	2.7	V
Continuous Diode Forward Current	I_S	$V_{GS}=0V, T_c=25^\circ\text{C}$	53	A
Reverse Recovery Time	t_{rr}	$V_{GS}=0V$,	81	Ns
Reverse Recovery Charge	Q_{rr}	$I_{SD}=30A, V_{DS}=400V$,	274	nC
Peak Reverse Recovery Current	I_{rrm}	$di/dt=300A/\mu s$	6.4	A

Gate Charge Characteristics ($T_c = 25^\circ\text{C}$ unless otherwise specified)

Parameter	Symbol	Test Conditions	Value	Unit
Gate to Source Charge	Q_{GS}	$V_{DS}=1200V$, $V_{GS}=-5/+20V$, $I_D=30A$	79	nC
Gate to Drain Charge	Q_{GD}		99	
Total Gate Charge	Q_G		304	
Gate plateau voltage	V_{pl}		7.5	V

Typical Device Performance

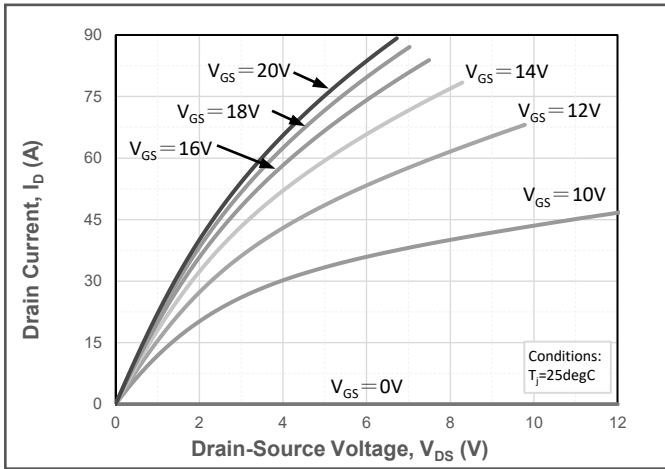

Fig.1 Forward Output Characteristics at $T_j = 25^\circ\text{C}$

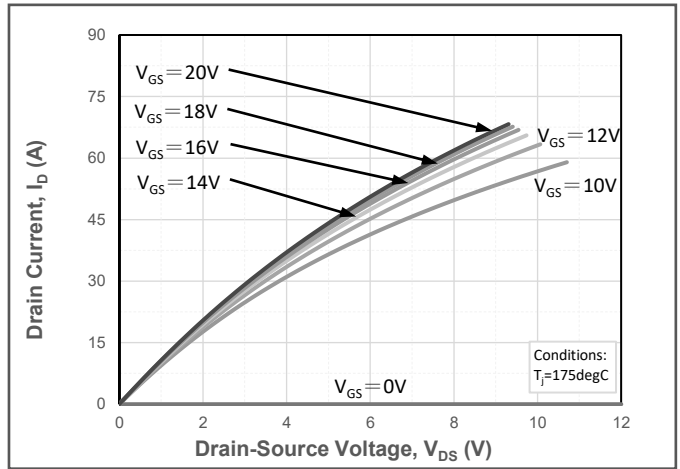

Fig.2 Forward Output Characteristics at $T_j = 175^\circ\text{C}$

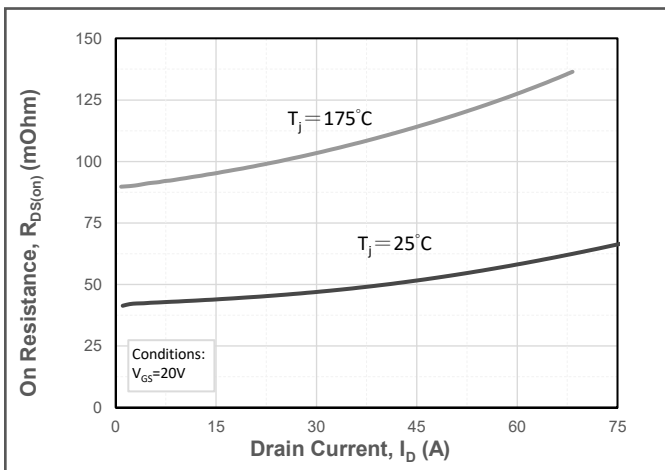

Fig.3 On-Resistance vs. Drain Current for Various T_j

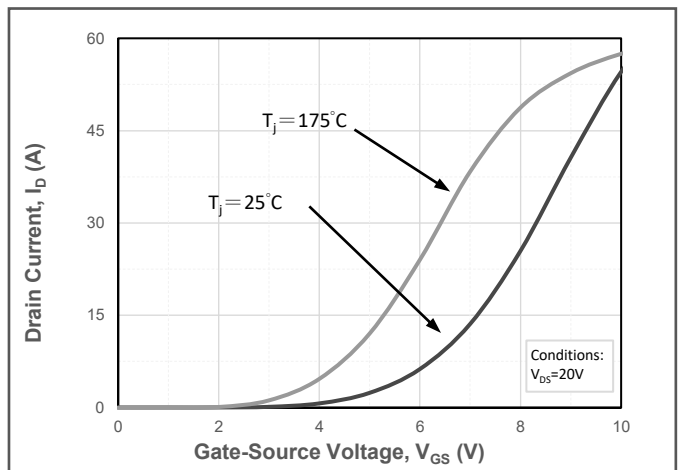

Fig.4 Transfer Characteristics for Various T_j

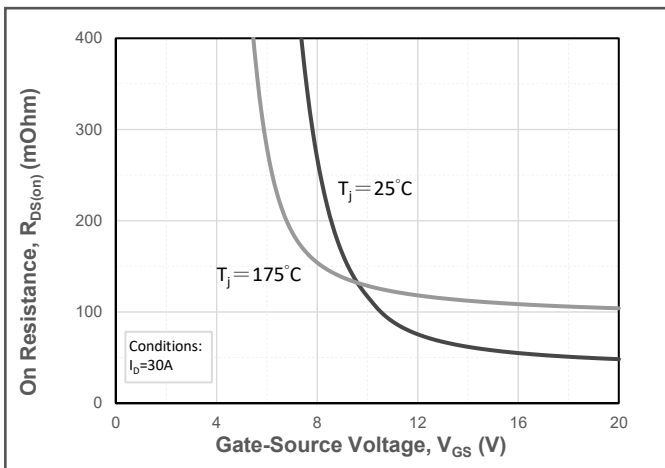

Fig.5 On-Resistance vs. Gate Voltage for Various T_j

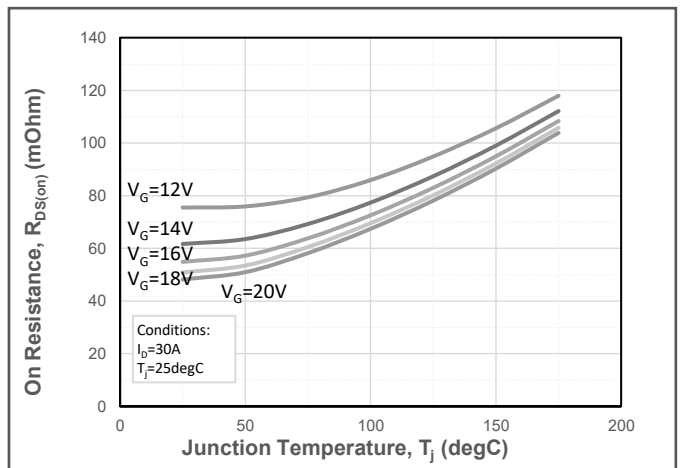

Fig.6 On-Resistance vs. Temperature for Various Gate Voltage

Typical Device Performance

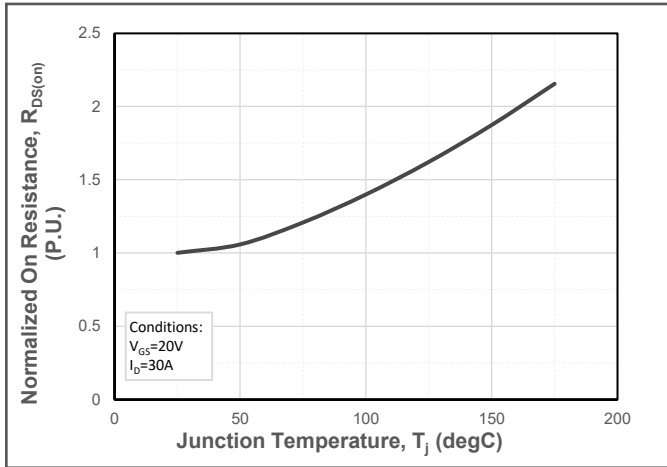

Fig.7 Normalized On-Resistance vs. Temperature

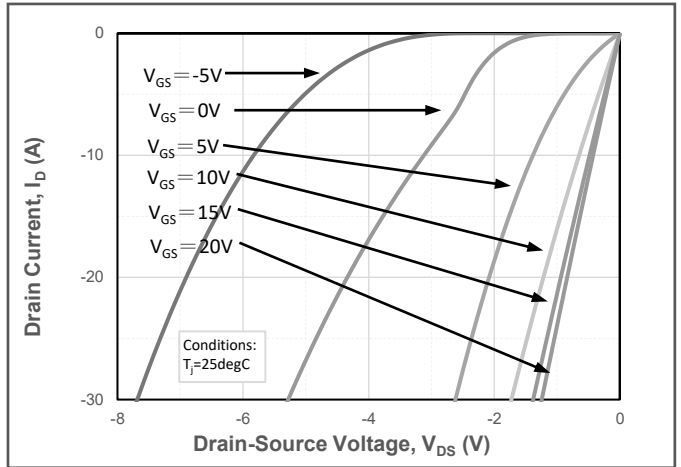

Fig.8 Reverse Output Characteristics at $T_j = 25^\circ C$

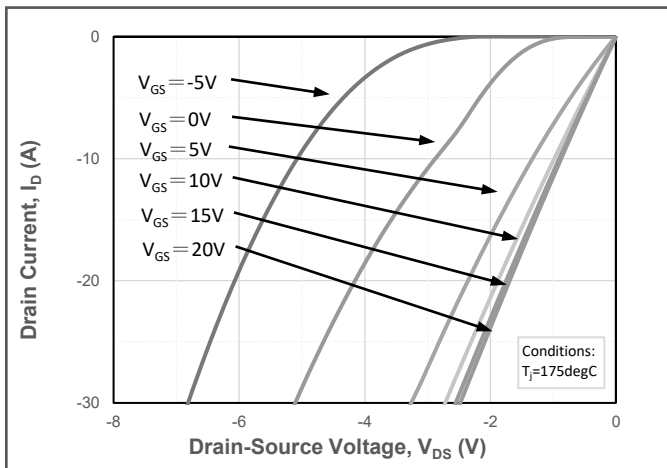

Fig.9 Reverse Output Characteristics at $T_j = 175^\circ C$

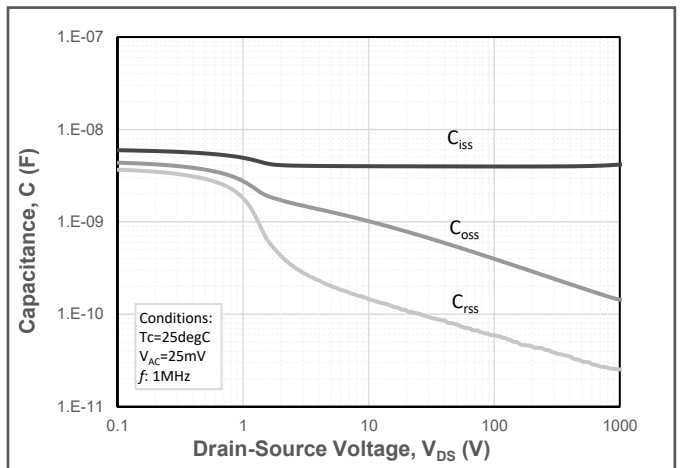

Fig.10 Capacitances vs. Drain to Source Voltage

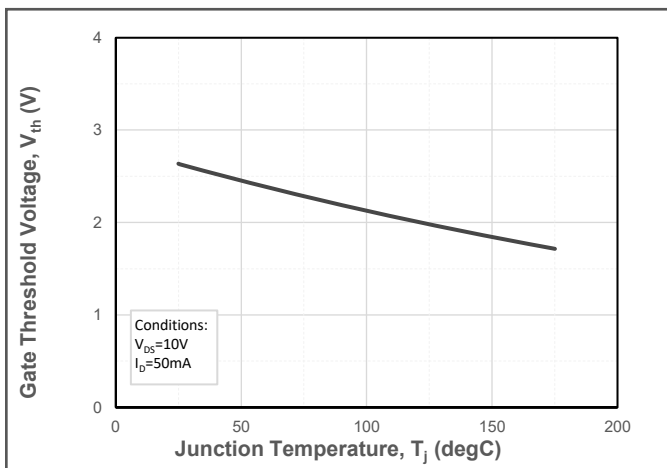

Fig.11 Threshold Voltage vs. Temperature

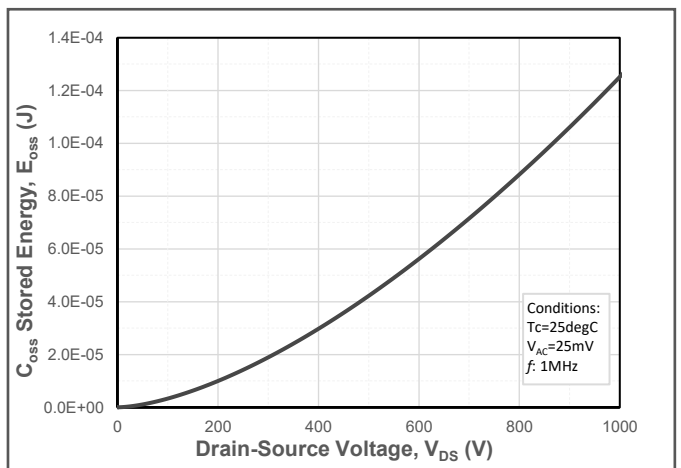

Fig.12 Output Capacitor Stored Energy

Typical Device Performance

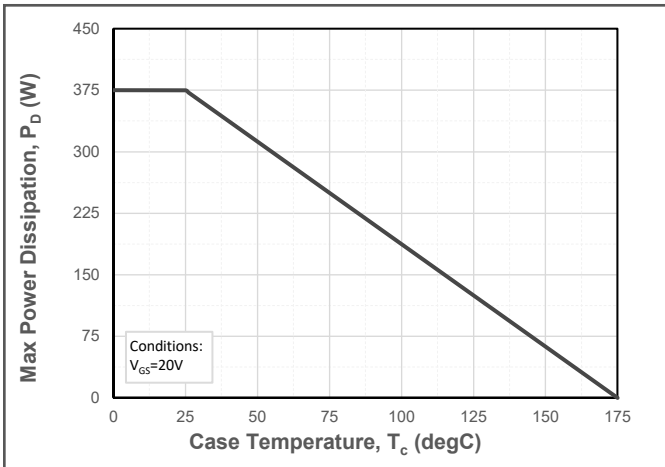

Fig.13 Maximum Power Dissipation Derating vs. Case Temperature

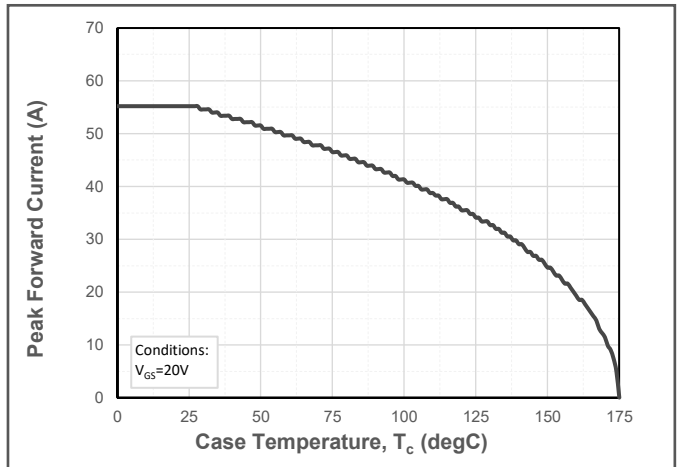

Fig.14 Drain Current Derating vs. Case Temperature

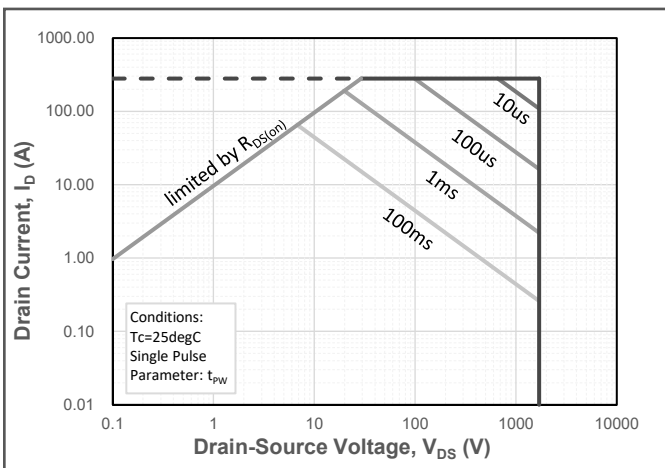

Fig.15 Safe Operating Area

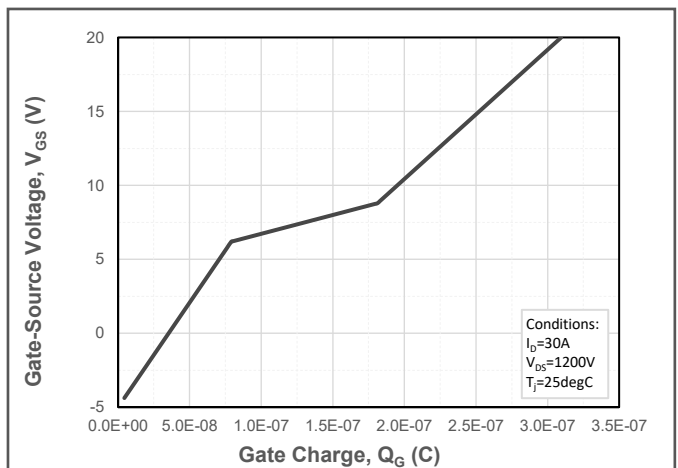

Fig.16 Gate Charge Characteristics

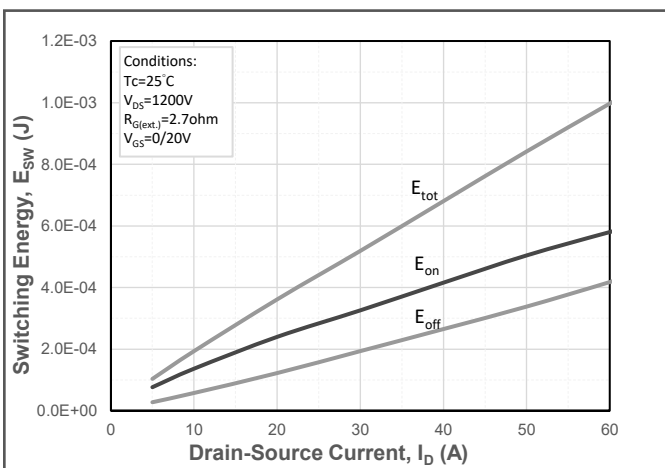

Fig.17 Clamped Inductive Switching Energy vs. Drain Current

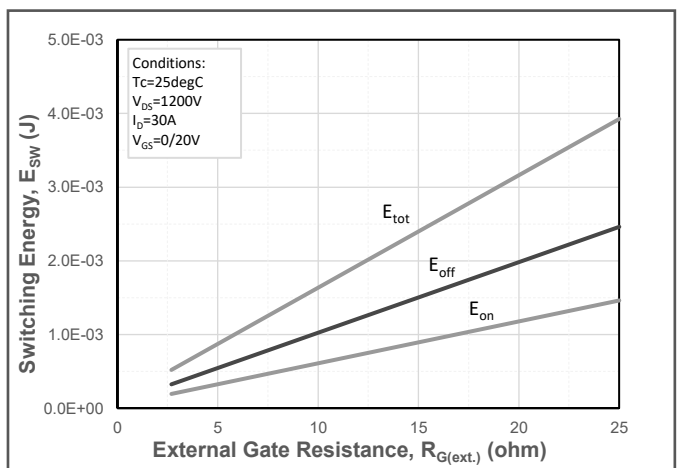

Fig.18 Clamped Inductive Switching Energy vs. External Gate Resistor ($R_{G(ext.)}$)

Typical Device Performance

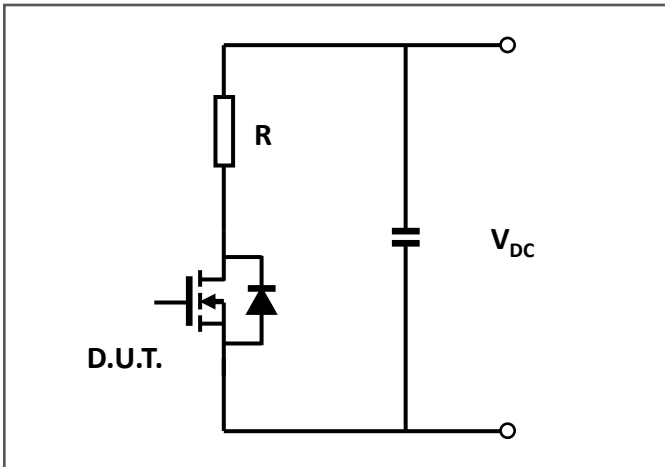

Fig.19 Schematic of Resistive Switching

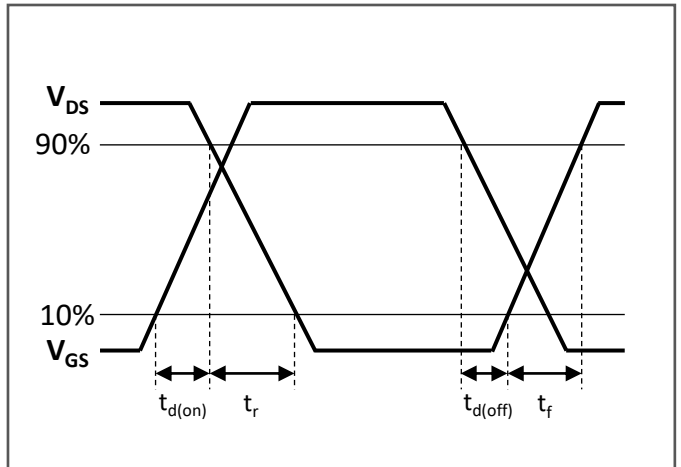

Fig.20 Switching Times Definition

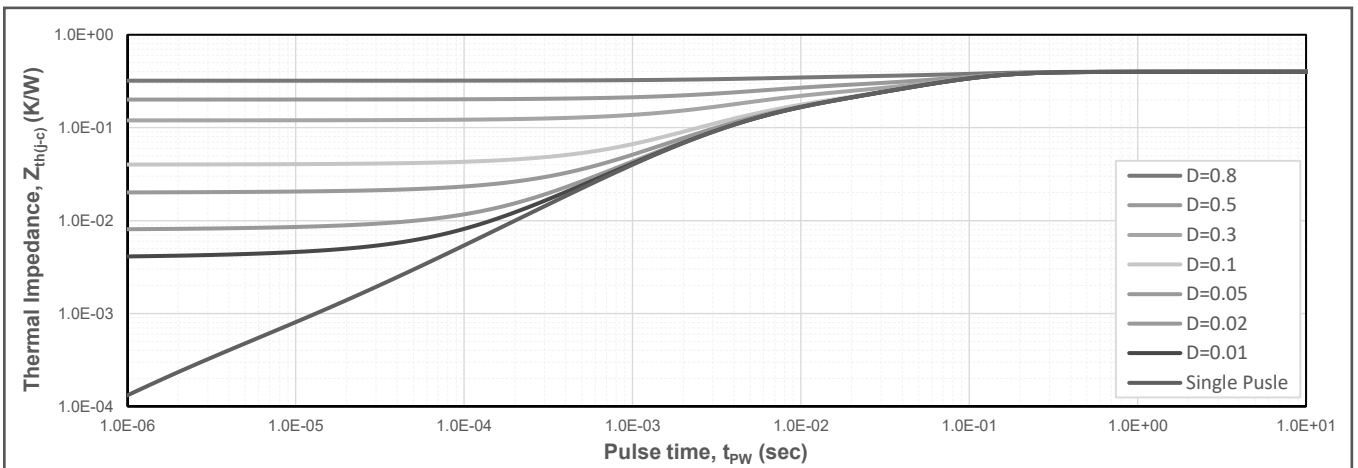
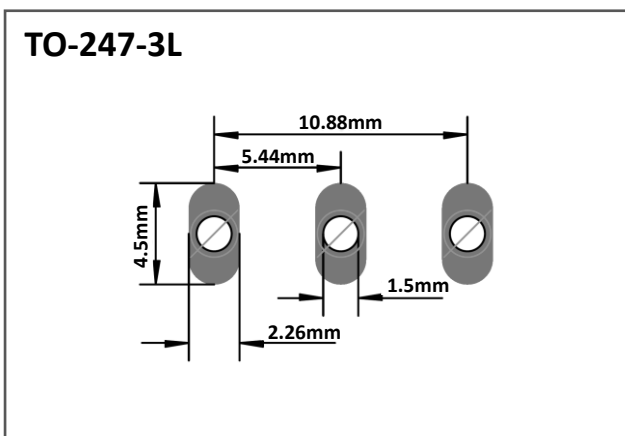
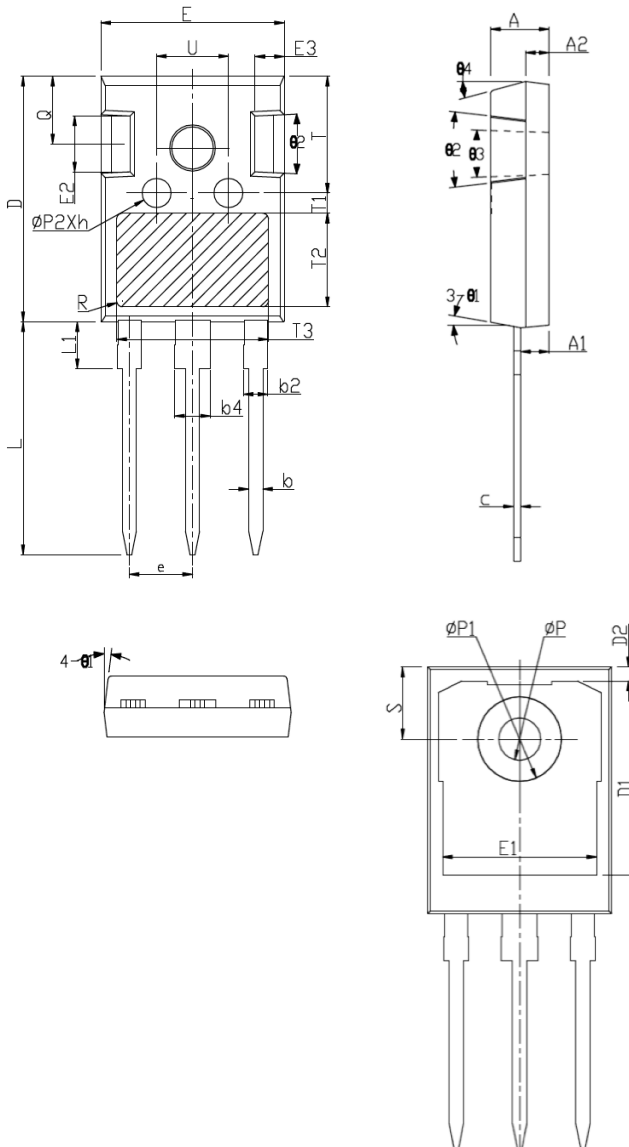

Fig.21 Transient Junction to Case Thermal Impedance

Recommended Solder Pad Layout



Package Dimensions



Symbol	mm		
	Min.	Typ.	Max.
A	4.75	5.00	5.25
A1	2.16	2.41	2.66
A2	1.85	2.00	2.15
b	1.11	1.21	1.35
b2	1.90	2.01	2.25
b4	2.90	3.01	3.25
c	0.51	0.61	0.75
D	20.60	21.00	21.40
D1	16.15	16.55	16.95
D2	1.00	1.20	1.40
E	15.50	15.80	16.10
E1	13.00	13.30	13.60
E2	4.70	5.00	5.30
E3	2.25	2.50	2.75
e	5.44 BSC		
h	0.00	0.10	0.25
L	19.52	19.92	20.32
L1	-	-	4.30
ϕP	3.35	3.60	3.85
$\phi P1$	-	-	7.30
$\phi P2$	2.25	2.50	2.75
Q	5.50	5.80	6.10
S	6.15 BSC		
R	0.50 REF		
T	9.70	-	10.30
T1	1.65 REF		
T2	8.00 REF		
T3	12.80 REF		
U	5.90	-	6.50
$\theta 1$	4°	7°	10°
$\theta 2$	2°	5°	8°
$\theta 3$	1°	-	2°
$\theta 4$	10°	15°	20°

Notes

- The information provided herein is subject to change without notice.