

650V Silicon Carbide Schottky Diode

V_{RRM}	=	650	V
$I_F (T_C \leq 135^\circ\text{C})$	=	36	A**
Q_C	=	72	nC**

Features

- Zero Reverse Recovery Current
- Zero Forward Recovery Voltage
- Positive Temperature Coefficient on V_F
- Temperature-independent Switching
- 175°C Operating Junction Temperature

Benefits

- Replace Bipolar with Unipolar Device
- Reduction of Heat Sink Size
- Parallel Devices Without Thermal Runaway
- Essentially No Switching Losses

Applications

- Switch Mode Power Supplies
- Power Factor Correction
- AC/DC converters

Package



Part Number	Package	Marking
H3D30065P	TO-247-3	H3D30065P

Maximum Ratings

Symbol	Parameter	Value	Unit	Test Conditions	Note
V_{RRM}	Repetitive Peak Reverse Voltage	650	V	$T_C = 25^\circ\text{C}$	
V_{RSM}	Surge Peak Reverse Voltage	650	V	$T_C = 25^\circ\text{C}$	
V_R	DC Blocking Voltage	650	V	$T_C = 25^\circ\text{C}$	
I_F	Forward Current (Per leg/Device)	39/78 18/36 15/30	A	$T_C \leq 25^\circ\text{C}$ $T_C \leq 135^\circ\text{C}$ $T_C \leq 151^\circ\text{C}$	
I_{FSM}	Non-Repetitive Forward Surge Current	135*	A	$T_C = 25^\circ\text{C}$, $t_p = 8.3\text{ms}$, Half Sine Wave	
P_{tot}	Power Dissipation (Per leg/Device)	161/ 322	W	$T_C = 25^\circ\text{C}$	Fig.3
T_C	Maximum Case Temperature	151	$^\circ\text{C}$		
T_J, T_{STG}	Operating Junction and Storage Temperature	-55 to 175	$^\circ\text{C}$		
	TO-247 Mounting Torque	1	Nm	M3 Screw	

*Per Leg, **Per Device

Electrical Characteristics (Per Leg)

Symbol	Parameter	Typ.	Max.	Unit	Test Conditions	Note
V_F	Forward Voltage	1.4 1.75	1.65 2.3	V	$I_F = 15A, T_J = 25^\circ C$ $I_F = 15A, T_J = 175^\circ C$	Fig.1
I_R	Reverse Current	1 5	20 100	μA	$V_R = 650V, T_J = 25^\circ C$ $V_R = 650V, T_J = 175^\circ C$	Fig.2
C	Total Capacitance	865 88 72	/	pF	$V_R = 0V, T_J = 25^\circ C, f = 1MHz$ $V_R = 200V, T_J = 25^\circ C, f = 1MHz$ $V_R = 400V, T_J = 25^\circ C, f = 1MHz$	Fig.5
Q_C	Total Capacitive Charge	36	/	nC	$V_R = 650V, I_F = 15A$ $di/dt = 200A/\mu s, T_J = 25^\circ C$	Fig.4

Thermal Characteristics

Symbol	Parameter	Typ.	Unit	Note
$R_{\theta JC}$	Thermal Resistance from Junction to Case	0.93* 0.465**	$^\circ C/W$	Fig.6
$R_{\theta JA}$	Thermal Resistance from Junction to Ambient	80	$^\circ C/W$	
T_{sold}	Soldering Temperature	260	$^\circ C$	

*Per Leg, **Per Device

Typical Performance (Per Leg)

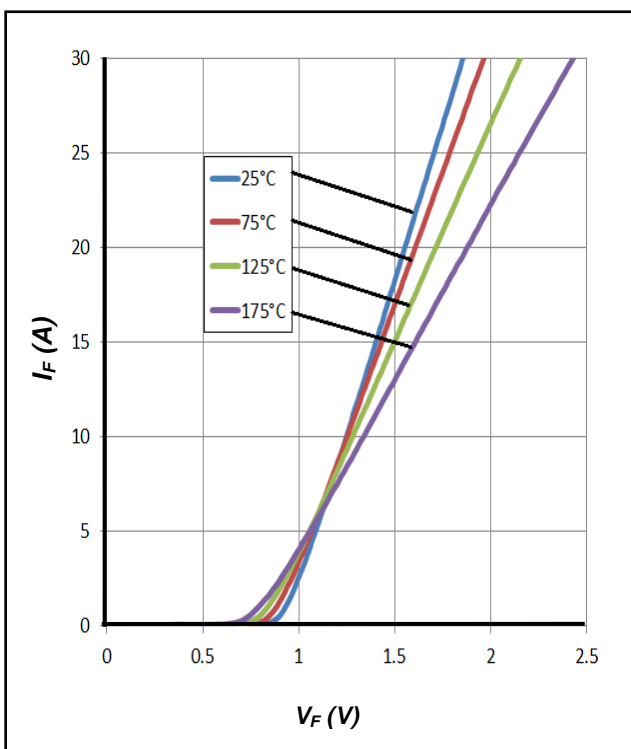

Figure 1. Forward Characteristics

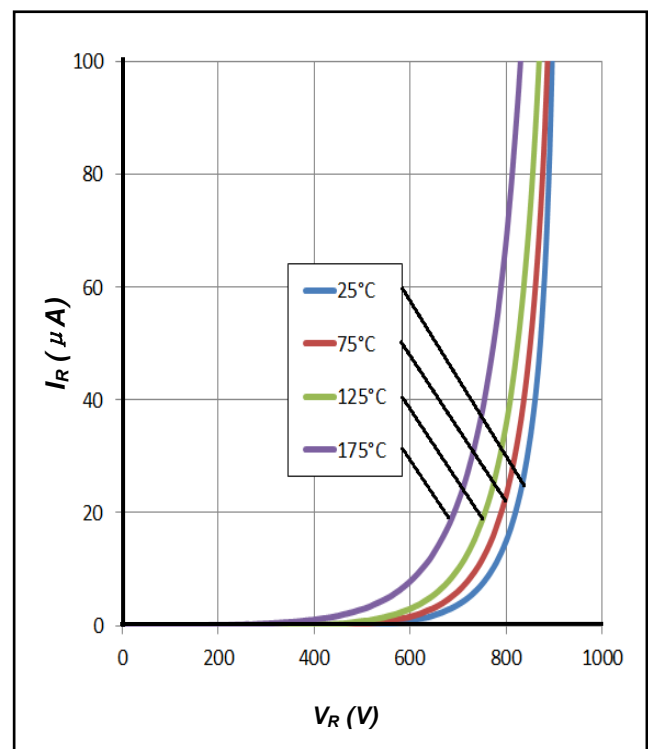

Figure 2. Reverse Characteristics

Typical Performance (Per Leg)

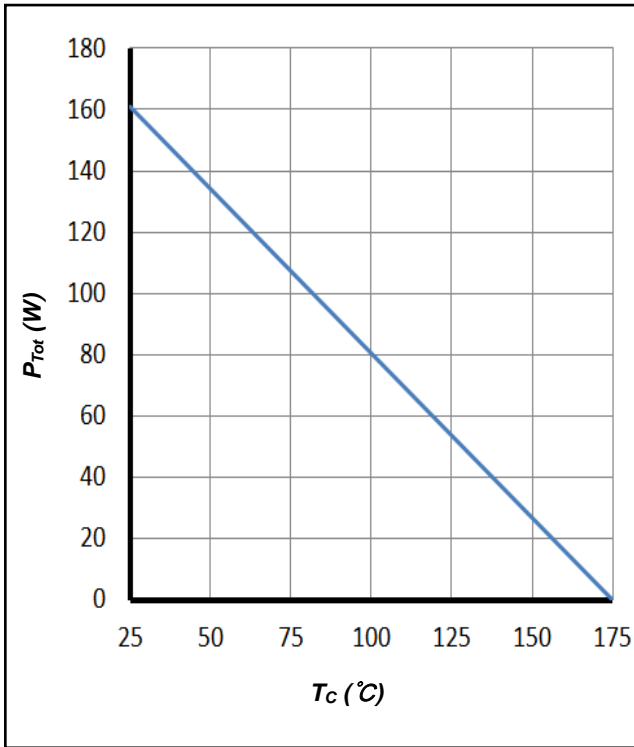

Figure 3. Power Derating

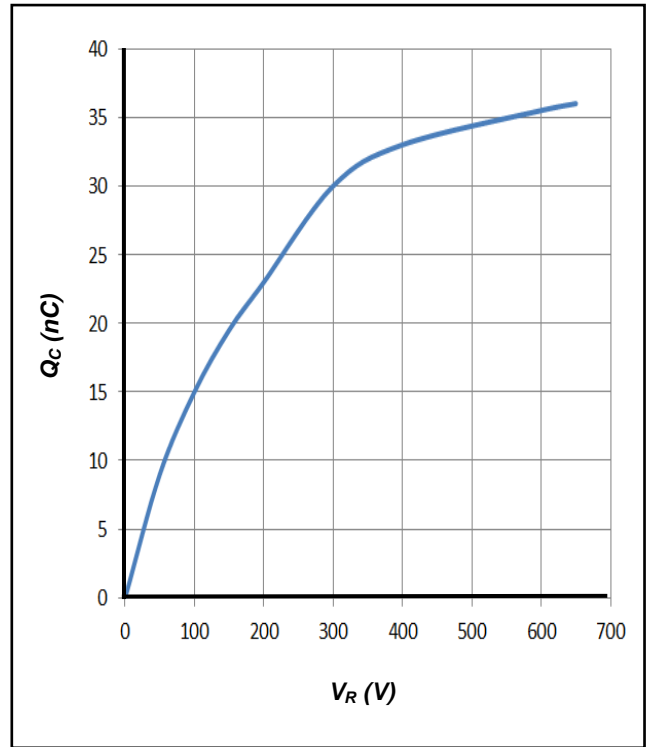

Figure 4. Total Capacitive Charge vs. Reverse Voltage

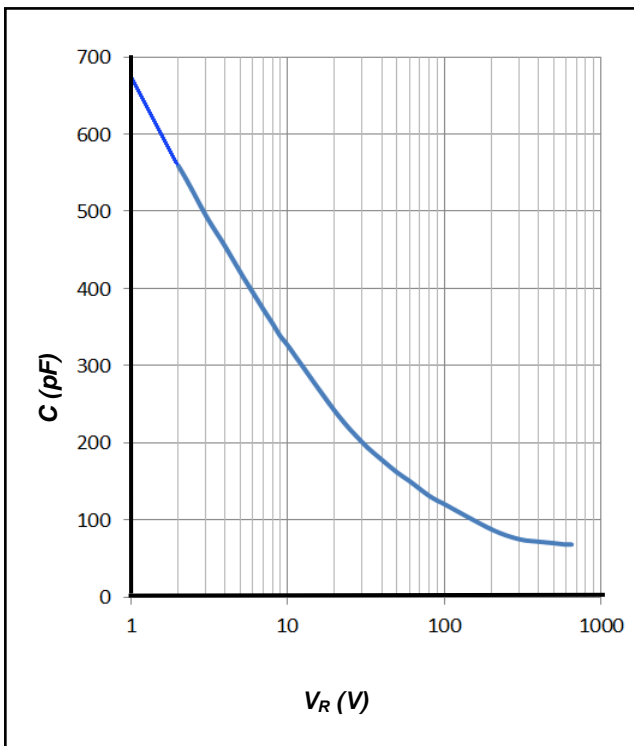

Figure 5. Total Capacitance vs. Reverse Voltage

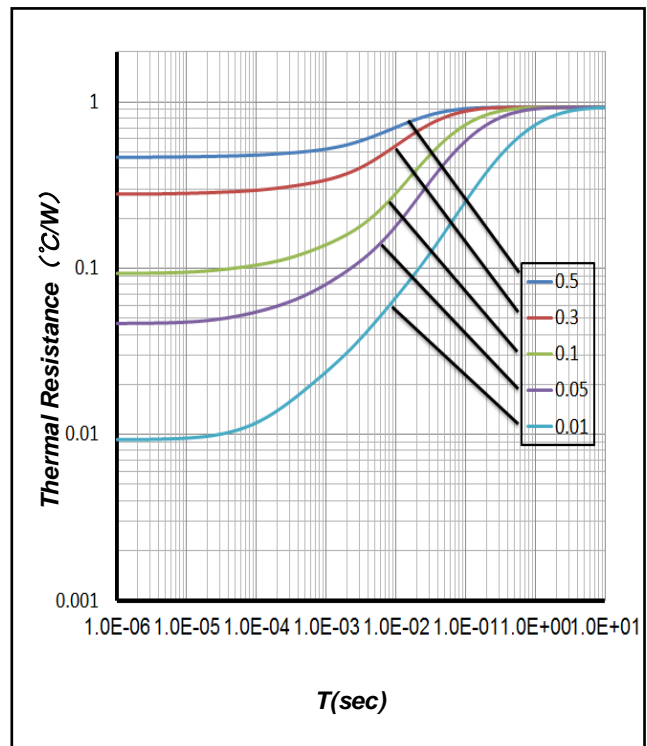
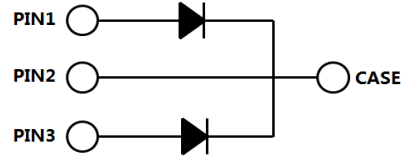
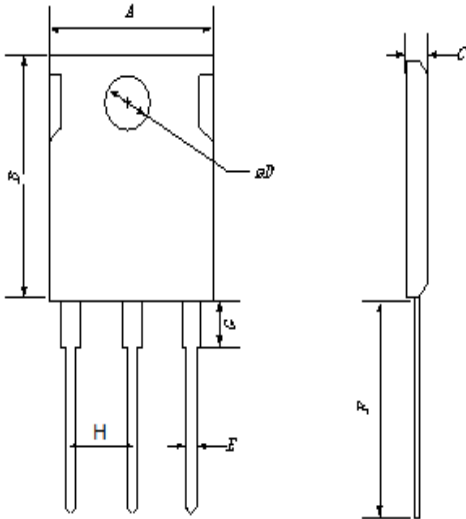

Figure 6. Transient Thermal Impedance

Package Dimensions

Package TO-247-3



Symbol	Min. (mm)	Typ. (mm)	Max. (mm)
A	14.18	15.75	17.33
B	18.45	20.5	22.55
C	4.50	5.00	5.50
D	3.15	3.50	3.85
E	1.08	1.20	1.32
F	18.27	20.30	22.33
G	4.21	4.68	5.15
H	4.91	5.46	6.01

Simplified Diode Model (Per Leg)

Equivalent IV Curve for Model

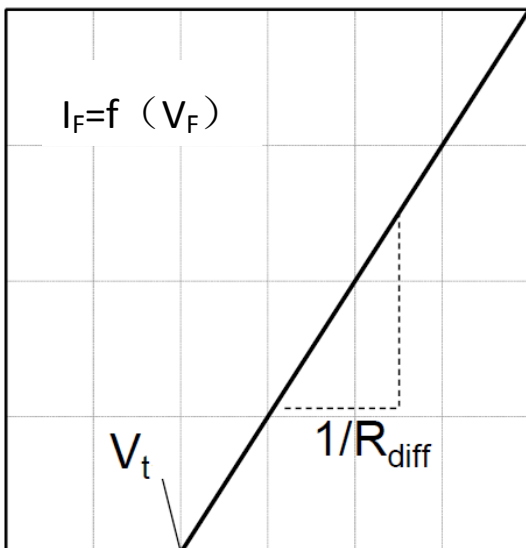

Mathematical Equation

$$V_F = V_t + I_F \times R_{diff}$$

$$V_t = -0.0011 \times T_j + 0.982 \text{ [V]}$$

$$R_{diff} = 3.38 \times 10^{-7} \times T_j^2 + 2.78 \times 10^{-5} \times T_j + 0.0169 \text{ [\Omega]}$$

Note:

T_j = Diode Junction Temperature In Degrees Celsius,
valid from 25°C to 175°C

I_F = Forward Current

Less than 60A