

Silicon N-Channel Power MOSFET

General Description :

HMT17N80 the silicon N-channel Enhanced VDMOSFETS, is obtained by the self-aligned planar Technology which reduce the conduction loss, improve switching performance and enhance the avalanche energy. The transistor can be used in various power switching circuit for system miniaturization and higher efficiency. The package form is TO-3PN, which accords with the RoHS standard.

Features :

- Fast Switching
- Low Gate Charge and R_{ds(on)}
- Low Reverse transfer capacitances
- 100% Single Pulse avalanche energy Test

Applications :

- Power switch circuit of adaptor and charger

V _{DSS}	800	V
I _D	17	A
P _D (T _C =25°C)	400	W
R _{DS(ON)TYP}	0.62	Ω

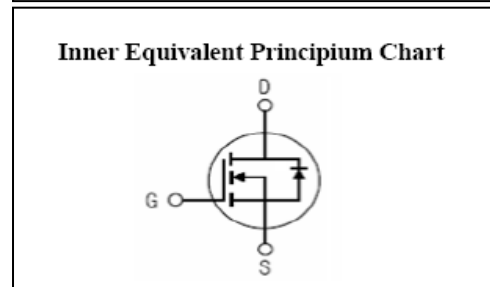
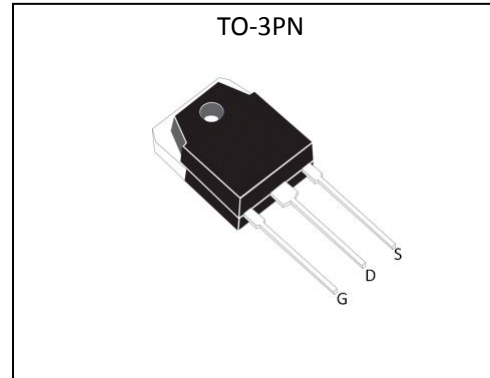

Absolute (T_c= 25°C unless otherwise specified) :

Symbol	Parameter	Rating	Units
V _{DSS}	Drain-to-Source Voltage	800	V
I _D	Continuous Drain Current	17	A
	Continuous Drain Current T _C =100°C	13	A
I _{DM} ^{a1}	Pulsed Drain Current	68	A
V _{GS}	Gate-to-Source Voltage	±30	V
E _{AS} ^{a2}	Single Pulse Avalanche Energy	1400	mJ
E _{AR} ^{a1}	Avalanche Energy ,Repetitive	120	mJ
I _{AR} ^{a1}	Avalanche Current	7	A
dv/dt ^{a3}	Peak Diode Recovery dv/dt	5.0	V/ns
P _D	Power Dissipation	400	W
	Derating Factor above 25°C	3.2	W/°C
T _J , T _{stg}	Operating Junction and Storage Temperature Range	150 , -55 to 150	°C
T _L	Maximum Temperature for Soldering	300	°C

Electrical Characteristics (Tc= 25°C unless otherwise specified) :

OFF Characteristics						
Symbol	Parameter	Test Conditions	Rating			Units
			Min.	Typ.	Max.	
V _{DSS}	Drain to Source Breakdown Voltage	V _{GS} =0V, I _D =250μA	800	--	--	V
ΔBV _{DSS} /ΔT _J	Bvdss Temperature Coefficient	I _D =250uA, Reference 25°C	--	0.8	--	V/°C
I _{DSS}	Drain to Source Leakage Current	V _{DS} =800V, V _{GS} =0V, T _a =25°C	--	--	10	μA
		V _{DS} =640V, V _{GS} =0V, T _a =125°C	--	--	1000	
I _{GSS(F)}	Gate to Source Forward Leakage	V _{GS} = +30V	--	--	1	μA
I _{GSS(R)}	Gate to Source Reverse Leakage	V _{GS} = -30V	--	--	-1	μA

ON Characteristics						
Symbol	Parameter	Test Conditions	Rating			Units
			Min.	Typ.	Max.	
R _{DS(ON)}	Drain-to-Source On-Resistance	V _{GS} =10V, I _D =8.5A	--	0.62	0.75	Ω
V _{GS(TH)}	Gate Threshold Voltage	V _{DS} =V _{GS} , I _D =250μA	2.5	--	4.5	V
Pulse width tp ≤ 380μs, δ ≤ 2%						

Dynamic Characteristics						
Symbol	Parameter	Test Conditions	Rating			Units
			Min.	Typ.	Max.	
g _{fs}	Forward Transconductance	V _{DS} =15V, I _D =8.5A	--	8.0	--	S
C _{iss}	Input Capacitance	V _{GS} =0V, V _{DS} =25V f=1.0MHz	--	2950	--	pF
C _{oss}	Output Capacitance		--	250	--	
C _{rss}	Reverse Transfer Capacitance		--	45	--	

Resistive Switching Characteristics						
Symbol	Parameter	Test Conditions	Rating			Units
			Min.	Typ.	Max.	
t _{d(ON)}	Turn-on Delay Time	I _D =8.5A, V _{DD} =400V V _{GS} =10V, R _G =9.1Ω	--	50	--	ns
t _r	Rise Time		--	90	--	
t _{d(OFF)}	Turn-Off Delay Time		--	33	--	
t _f	Fall Time		--	74	--	
Q _g	Total Gate Charge	I _D =8.5A, V _{DD} =400V V _{GS} =10V	--	64	--	nC
Q _{gs}	Gate to Source Charge		--	16	--	
Q _{gd}	Gate to Drain ("Miller") Charge		--	28	--	

Source-Drain Diode Characteristics						
Symbol	Parameter	Test Conditions	Rating			Units
			Min.	Typ.	Max.	
I_S	Continuous Source Current (Body Diode)		--	--	17	A
I_{SM}	Maximum Pulsed Current (Body Diode)		--	--	68	A
V_{SD}	Diode Forward Voltage	$I_S=17A, V_{GS}=0V$	--	--	1.5	V
t_{rr}	Reverse Recovery Time	$I_S=17A, T_j = 25^\circ C$	--	450	--	ns
Q_{rr}	Reverse Recovery Charge	$dI_F/dt=100A/us, V_{GS}=0V$	--	1800	--	nC
Pulse width $t_p \leq 380\mu s, \delta \leq 2\%$						

Symbol	Parameter	Typ.	Units
$R_{\theta JC}$	Junction-to-Case	0.32	$^\circ C/W$
$R_{\theta JA}$	Junction-to-Ambient	55	$^\circ C/W$

^{a1} : Repetitive rating; pulse width limited by maximum junction temperature

^{a2} : $L=10.0mH, I_D=23A, \text{Start } T_j=25^\circ C$

^{a3} : $I_{SD} = 17A, di/dt \leq 100A/us, V_{DD} \leq BV_{DS}, \text{Start } T_j=25^\circ C$

Test Circuit and Waveform

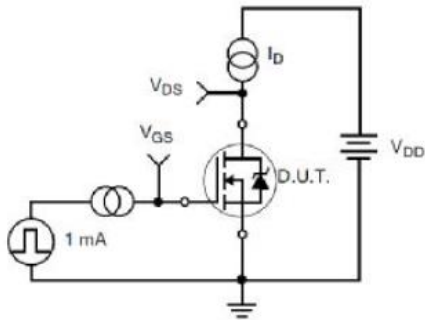

Figure 17. Gate Charge Test Circuit

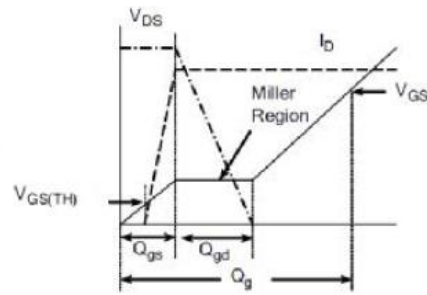

Figure 18. Gate Charge Waveform

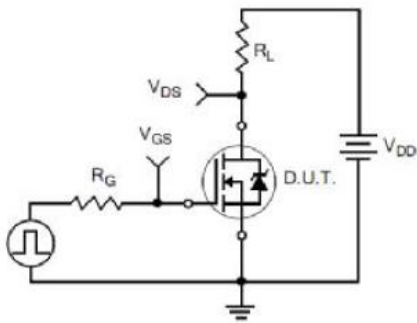

Figure 19. Resistive Switching Test Circuit

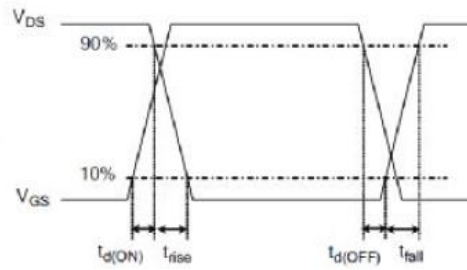

Figure 20. Resistive Switching Waveforms

Characteristics Curve

Fig. 1. Output Characteristics @ 25°C

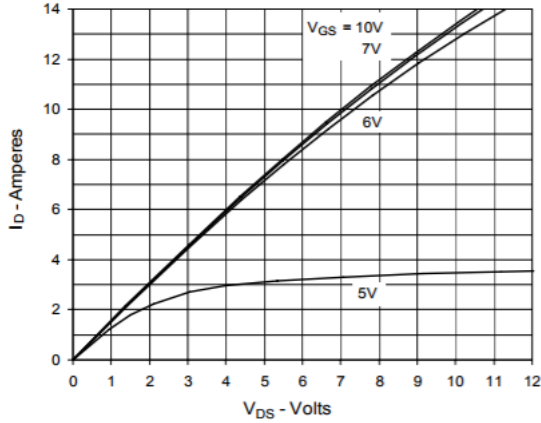

Fig. 2. Extended Output Characteristics @ 25°C

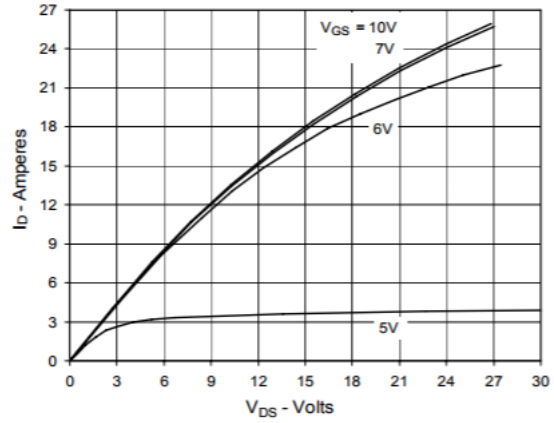

Fig. 3. Output Characteristics @ 125°C

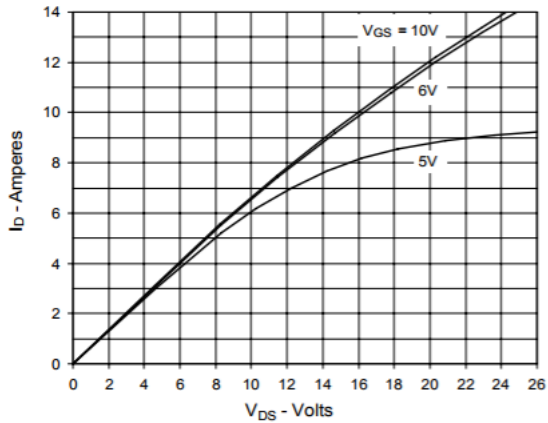

Fig. 4. $R_{DS(on)}$ Normalized to $I_D = 7A$ Value vs. Junction Temperature

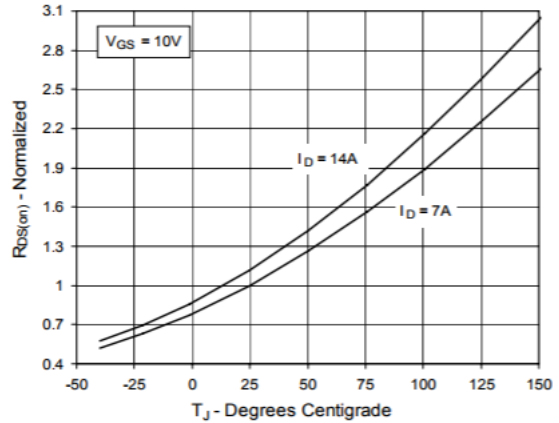

Fig. 5. $R_{DS(on)}$ Normalized to $I_D = 7A$ Value vs. Drain Current

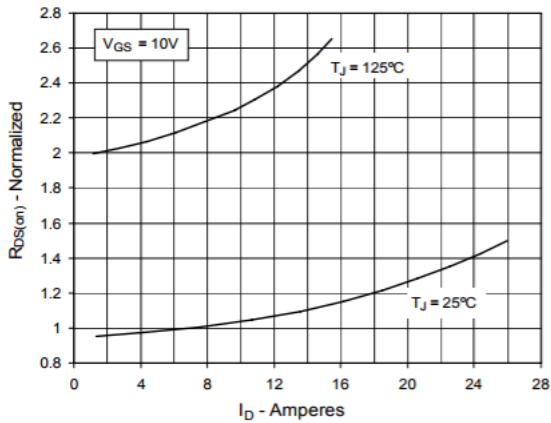

Fig. 6. Maximum Drain Current vs. Case Temperature

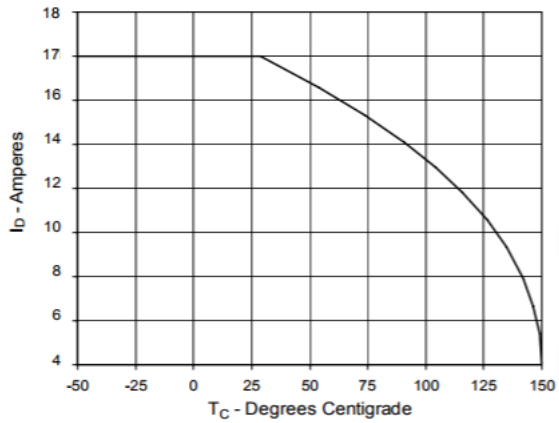

Fig. 7. Input Admittance

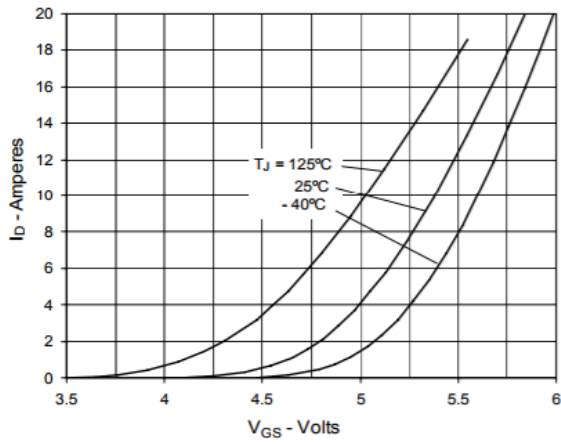

Fig. 8. Transconductance

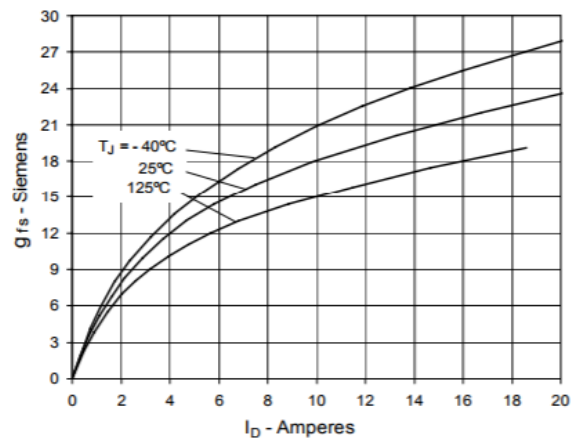

Fig. 9. Forward Voltage Drop of Intrinsic Diode

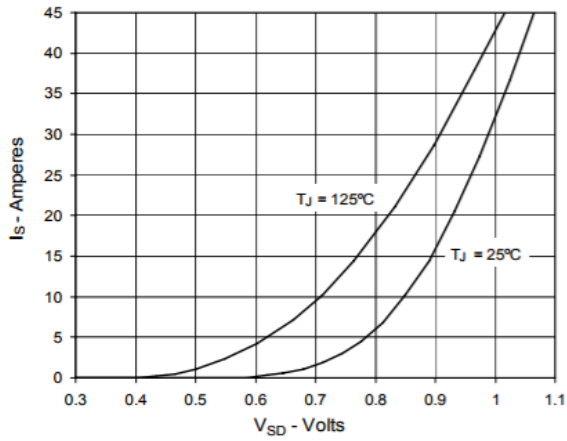

Fig. 10. Gate Charge

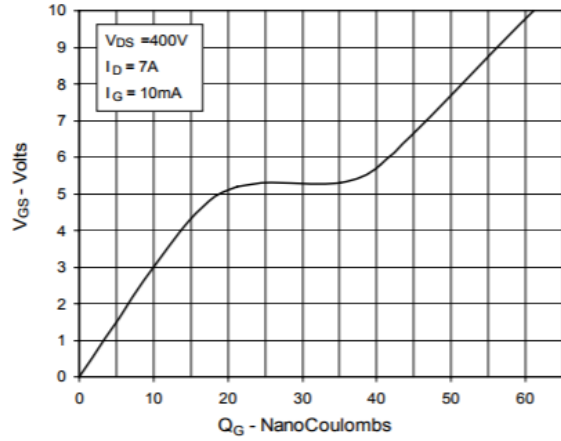

Fig. 11. Capacitance

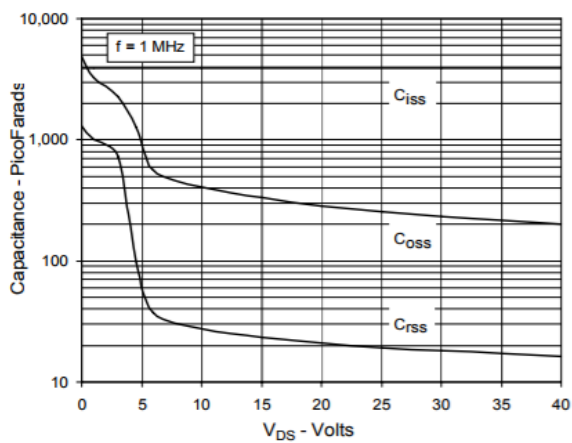

Fig. 13. Maximum Transient Thermal Resistance

