

Silicon N-Channel Power MOSFET

General Description:

HMP62N80FD, the silicon N-channel Enhanced VDMOSFET, is obtained by the self-aligned planar Technology which reduce the conduction loss, improve switching performance and enhance the avalanche energy. The transistor can be used in various power switching circuit for system miniaturization and higher efficiency. The package form is TO-247PLUS, which accords with the RoHS standard.

Features:

- Fast body diode
- Low ON Resistance ($R_{ds(on)} \leq 0.16\Omega$)
- Low Gate Charge
- Low Reverse transfer capacitances
- 100% Single Pulse avalanche energy Test

Applications:

- Power switch circuit of adaptor and charger
- Motor Control applications
- Zero Voltage Switching SMPS

Absolute (Tc=25°C unless otherwise specified):

Symbol	Parameter	Rating	Units
V _{DSS}	Drain-to-Source Voltage	800	V
I _D	Continuous Drain Current	62	A
I _{DM} ^{a1}	Pulsed Drain Current	186	A
V _{GS}	Gate-to-Source Voltage	±30	V
E _{AS} ^{a2}	Single Pulse Avalanche Energy	5000	mJ
P _D	Power Dissipation	1250	W
	Derating Factor above 25°C	10	W/°C
T _J , T _{stg}	Operating Junction and Storage Temperature Range	150, -55 to 150	°C
T _L	Maximum Temperature for Soldering	300	°C

Caution Stresses greater than those in the "Absolute Maximum Ratings" may cause permanent damage to the device

V _{DSS}	800	V
I _D	62	A
P _D (T _C =25°C)	1250	W
R _{DS(ON).TYP.}	0.13	Ω

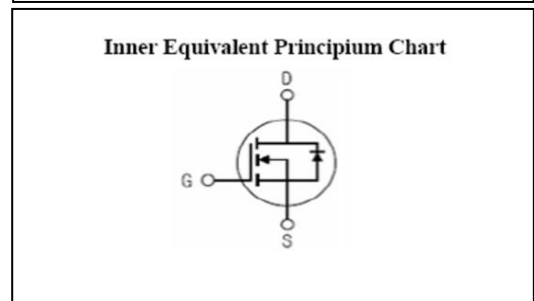
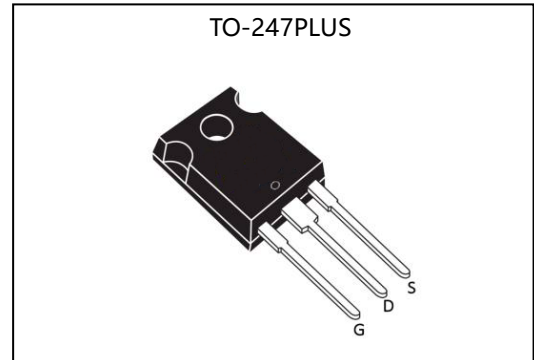

Thermal Characteristics

Symbol	Parameter	Rating	Units
$R_{\theta JC}$	Thermal Resistance, Junction-to-Case	0.1	$^{\circ}\text{C}/\text{W}$
$R_{\theta JA}$	Thermal Resistance, Junction-to-Ambient	35.7	$^{\circ}\text{C}/\text{W}$

Electrical Characteristics ($T_c = 25^{\circ}\text{C}$ unless otherwise specified) :

OFF Characteristics

Symbol	Parameter	Test Conditions	Rating			Units
			Min.	Typ.	Max.	
V_{DSS}	Drain to Source Breakdown Voltage	$V_{GS}=0\text{V}, I_D=250\mu\text{A}$	800	--	--	V
$\Delta BV_{DSS}/\Delta T_J$	Bvdss Temperature Coefficient	$I_D=250\mu\text{A}, \text{Reference } 25^{\circ}\text{C}$	--	0.55	--	$\text{V}/^{\circ}\text{C}$
I_{DSS}	Drain to Source Leakage Current	$V_{DS}=800\text{V}, V_{GS}=0\text{V}, T_a=25^{\circ}\text{C}$	--	--	50	μA
		$V_{DS}=640\text{V}, V_{GS}=0\text{V}, T_a=125^{\circ}\text{C}$	--	--	5000	
$I_{GSS(F)}$	Gate to Source Forward Leakage	$V_{GS}=+30\text{V}$	--	--	500	nA
$I_{GSS(R)}$	Gate to Source Reverse Leakage	$V_{GS}=-30\text{V}$	--	--	-500	nA

ON Characteristics

Symbol	Parameter	Test Conditions	Rating			Units
			Min.	Typ.	Max.	
$R_{DS(ON)}$	Drain-to-Source On-Resistance	$V_{GS}=10\text{V}, I_D=31\text{A}$	--	0.13	0.16	Ω
$V_{GS(TH)}$	Gate Threshold Voltage	$V_{DS}=V_{GS}, I_D=250\mu\text{A}$	2.0	--	5.0	V
g_{fs}	Forward Trans conductance	$V_{DS}=10\text{V}, I_D=10\text{A}$	--	15	--	S

Pulse width < 380 μs ; duty cycle < 2%.

Dynamic Characteristics

Symbol	Parameter	Test Conditions	Rating			Units
			Min.	Typ.	Max.	
C_{iss}	Input Capacitance	$V_{GS}=0\text{V}, V_{DS}=25\text{V}$ $f=1.0\text{MHz}$	--	13500	--	μF
C_{oss}	Output Capacitance		--	1200	--	
C_{rss}	Reverse Transfer Capacitance		--	25	--	

Resistive Switching Characteristics

Symbol	Parameter	Test Conditions	Rating			Units
			Min.	Typ.	Max.	
$t_{d(ON)}$	Turn-on Delay Time	$I_D=62\text{A}, V_{DD}=400\text{V}$ $V_{GS}=10\text{V}, R_g=10\Omega$	--	11	--	ns
t_r	Rise Time		--	22	--	
$t_{d(OFF)}$	Turn-Off Delay Time		--	38	--	
t_f	Fall Time		--	30	--	
Q_g	Total Gate Charge	$I_D=62\text{A}, V_{DD}=400\text{V}$ $V_{GS}=10\text{V}$	--	32	--	nC
Q_{gs}	Gate to Source Charge		--	8.6	--	
Q_{gd}	Gate to Drain ("Miller") Charge		--	10	--	

Source-Drain Diode Characteristics						
Symbol	Parameter	Test Conditions	Rating			Units
			Min.	Typ.	Max.	
I_{SD}	Continuous Source Current (Body Diode)		--	--	62	A
I_{SM}	Maximum Pulsed Current (Body Diode)		--	--	186	A
V_{SD}	Diode Forward Voltage	$I_S=62A, V_{GS}=0V$	--	--	1.5	V
t_{rr}	Reverse Recovery Time	$I_S=62A, T_J=25^\circ C$	--	170	--	ns
Q_{rr}	Reverse Recovery Charge	$dI_F/dt=100A/\mu s, V_{GS}=0V$	--	500	--	nC

a1: Repetitive rating; pulse width limited by maximum junction temperature

a2: L=10mH, $I_D=13A$, Start $T_J=25^\circ C$

Characteristics Curve:

Fig. 1. Output Characteristics @ $T_J = 25^\circ\text{C}$

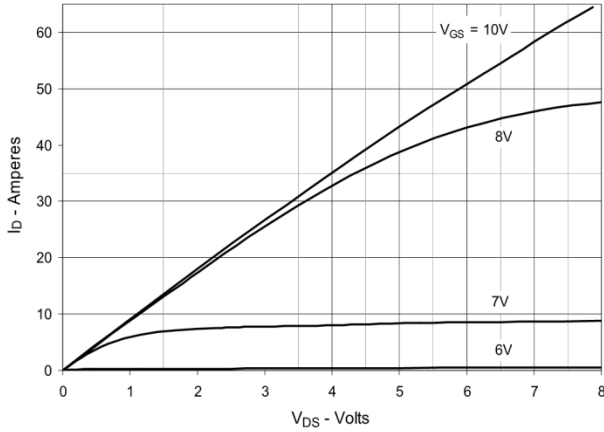

Fig. 2. Extended Output Characteristics @ $T_J = 25^\circ\text{C}$

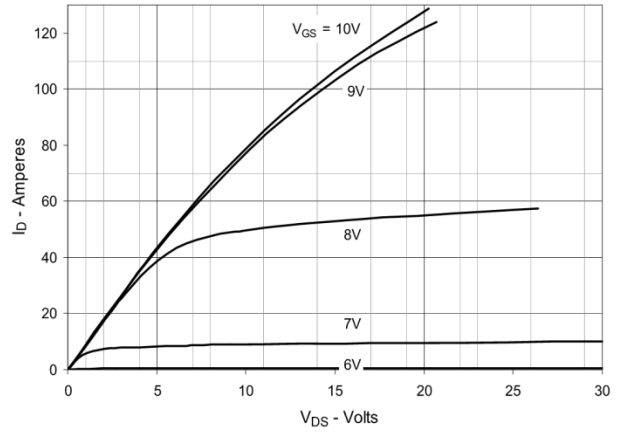

Fig. 3. Output Characteristics @ $T_J = 125^\circ\text{C}$

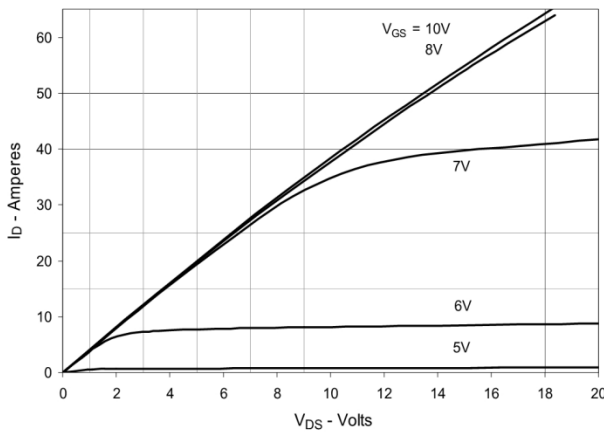

Fig. 4. $R_{DS(on)}$ Normalized to $I_D = 31\text{A}$ Value vs. Junction Temperature

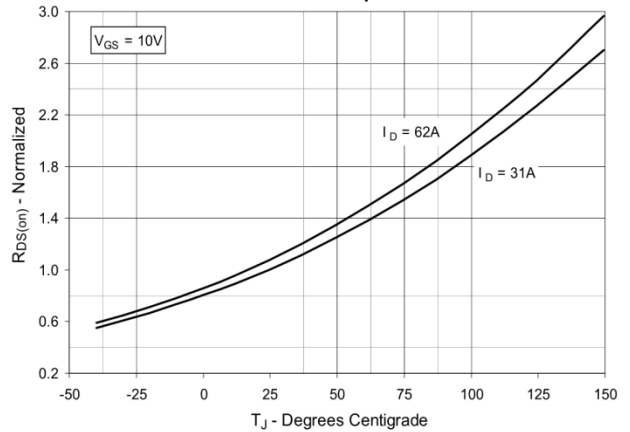

Fig. 5. $R_{DS(on)}$ Normalized to $I_D = 31\text{A}$ Value vs. Drain Current

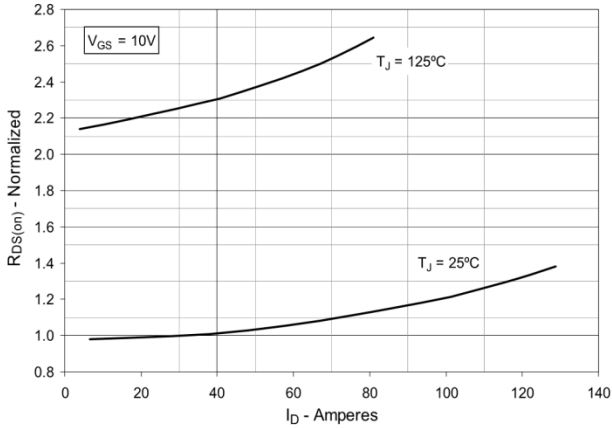

Fig. 6. Maximum Drain Current vs. Case Temperature

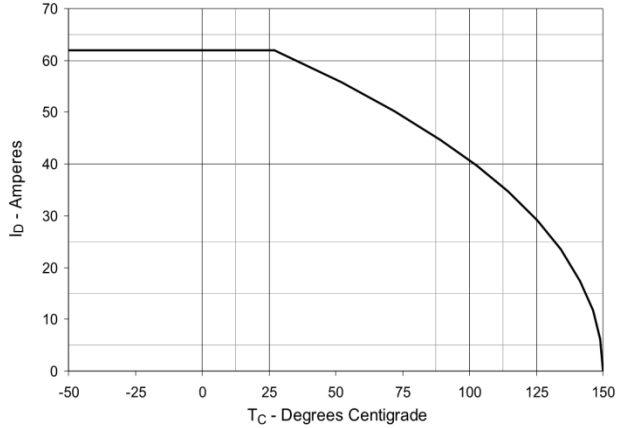

Fig. 7. Input Admittance

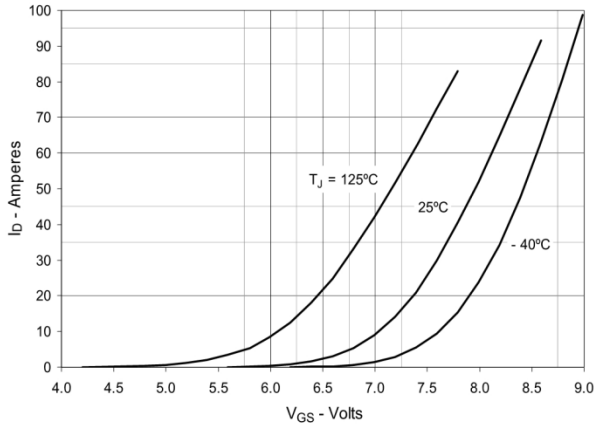

Fig. 8. Transconductance

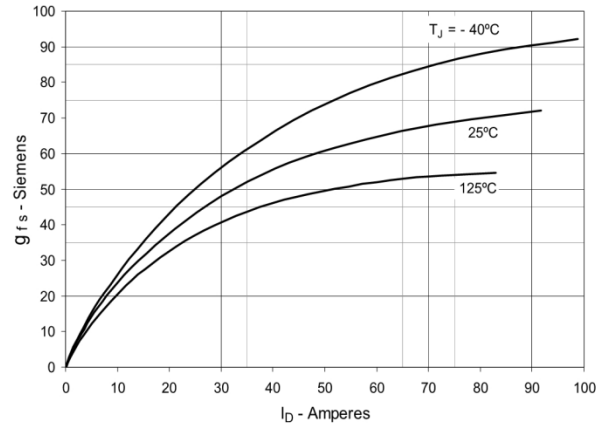

Fig. 9. Forward Voltage Drop of Intrinsic Diode

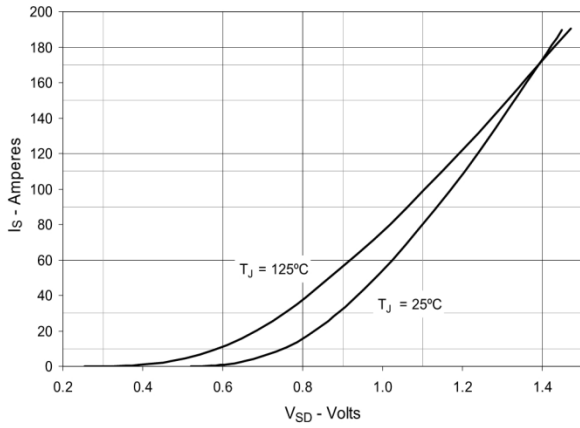

Fig. 10. Gate Charge

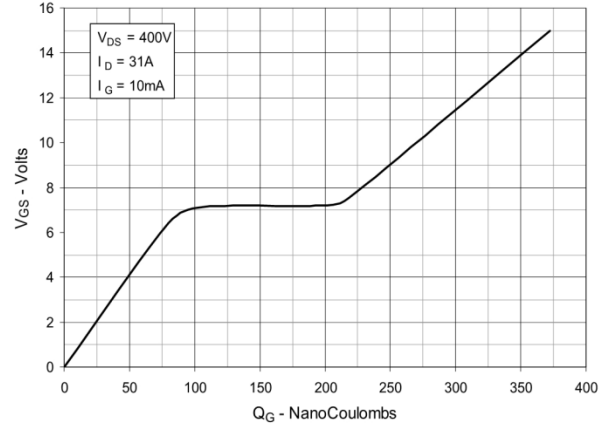

Fig. 11. Capacitance

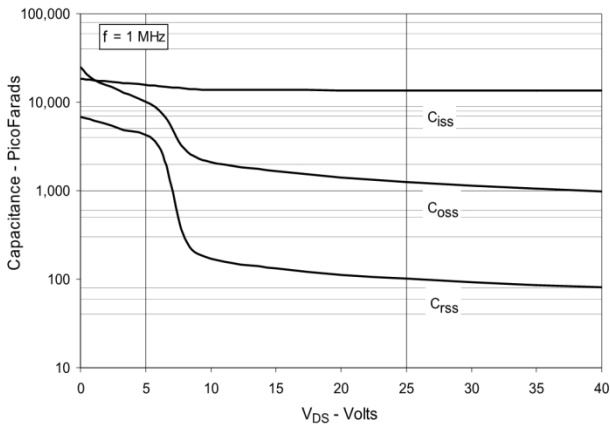

Fig. 12. Forward-Bias Safe Operating Area

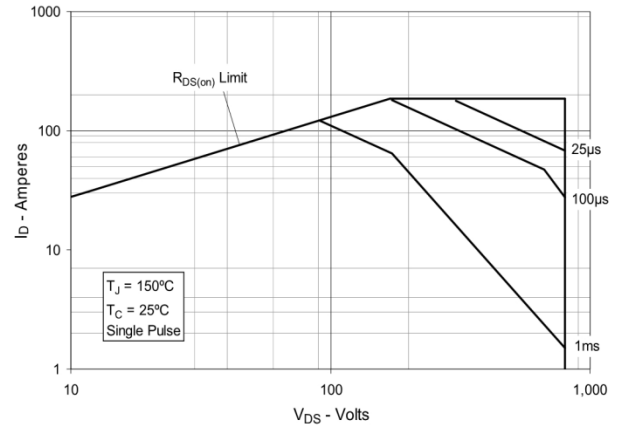

Fig. 13. Maximum Transient Thermal Impedance

