

Silicon N-Channel Power MOSFET

General Description:

HMP1N250, the silicon N-channel Enhanced VDMOSFET, is obtained by the self-aligned very high Voltage planar Technology which reduce the conduction loss, improve switching performance and enhance the avalanche energy. The transistor can be used in various power switching circuit for system miniaturization and higher efficiency. The package form is TO-247, which accords with the RoHS standard.

Features:

- Fast Switching
- High Blocking Voltage
- Low Gate Charge Minimize Switching loss
- Fast Recovery Body Diode
- 100% Single Pulse avalanche energy Test

Applications:

- High Voltage Power Supplies
- Capacitor Discharge
- Pulse Circuits

| | | |
|-----------------------------|------|----------|
| V_{DSS} | 2500 | V |
| I_D | 1.5 | A |
| $P_D(T_C=25^\circ\text{C})$ | 250 | W |
| $R_{DS(ON)max}$ | 40 | Ω |

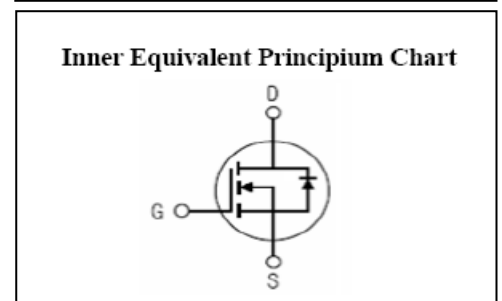
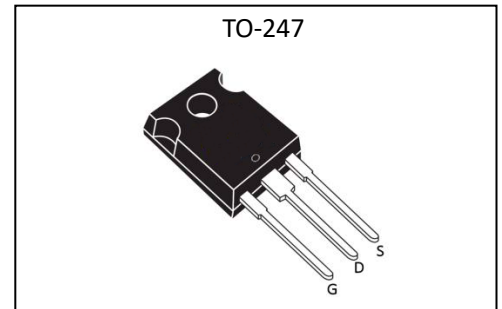

Absolute (Tc= 25°C unless otherwise specified):

| Symbol | Parameter | Rating | Units |
|----------------|-------------------------------------------------------------------------------|-----------------|-------|
| V_{DSS} | Drain-to-Source Voltage | 2500 | V |
| I_D | Continuous Drain Current | 1.5 | A |
| I_{DM} | Pulsed Drain Current at $V_{GS}=10V$ | 6 | A |
| V_{GS} | Gate-to-Source Voltage | ± 30 | V |
| E_{AS} | Single Pulse Avalanche Energy | 250 | mJ |
| dv/dt | Peak Diode Recovery dv/dt | 5.0 | V/ns |
| P_D | Power Dissipation | 250 | W |
| | Derating Factor above 25°C | 0.67 | W/°C |
| T_J, T_{stg} | Operating Junction and Storage Temperature Range | 150, -55 to 150 | °C |
| T_L | Maximum Temperature for Soldering | 300 | °C |
| T_{PAK} | Leads at 0.63 in(1.6mm) from Case for 10 seconds, Package Body for 10 seconds | 260 | °C |

Caution Stresses greater than those in the "Absolute Maximum Ratings" may cause permanent damage to the device

Thermal Characteristics

| Symbol | Parameter | Rating | Units |
|-----------------|-----------------------------------------|--------|-----------------------------|
| $R_{\theta JC}$ | Thermal Resistance, Junction-to-Case | 0.5 | $^{\circ}\text{C}/\text{W}$ |
| $R_{\theta JA}$ | Thermal Resistance, Junction-to-Ambient | 40 | $^{\circ}\text{C}/\text{W}$ |

Electrical Characteristics (Tc= 25°C unless otherwise specified) :

| OFF Characteristics | | | | | | |
|---------------------|-----------------------------------|------------------------------------------------------------------|--------|------|------|---------------|
| Symbol | Parameter | Test Conditions | Rating | | | Units |
| | | | Min. | Typ. | Max. | |
| V_{DSS} | Drain to Source Breakdown Voltage | $V_{GS}=0\text{V}, I_D=250\mu\text{A}$ | 2500 | -- | -- | V |
| I_{DSS} | Drain to Source Leakage Current | $V_{DS}=2500\text{V}, V_{GS}=0\text{V}, T_a=25^{\circ}\text{C}$ | -- | -- | 20 | μA |
| | | $V_{DS}=2000\text{V}, V_{GS}=0\text{V}, T_a=125^{\circ}\text{C}$ | -- | -- | 250 | |
| $I_{GSS(F)}$ | Gate to Source Forward Leakage | $V_{GS}=+30\text{V}$ | -- | -- | 100 | nA |
| $I_{GSS(R)}$ | Gate to Source Reverse Leakage | $V_{GS}=-30\text{V}$ | -- | -- | -100 | nA |

| ON Characteristics | | | | | | |
|--------------------|-------------------------------|---------------------------------------|--------|------|------|----------|
| Symbol | Parameter | Test Conditions | Rating | | | Units |
| | | | Min. | Typ. | Max. | |
| $R_{DS(ON)}$ | Drain-to-Source On-Resistance | $V_{GS}=10\text{V}, I_D=0.75\text{A}$ | -- | -- | 40 | Ω |
| $V_{GS(TH)}$ | Gate Threshold Voltage | $V_{DS}=V_{GS}, I_D=250\mu\text{A}$ | 2.5 | -- | 4.5 | V |
| g_{fs} | Forward Transconductance | $V_{DS}=60\text{V}, I_D=0.75\text{A}$ | -- | 2.0 | -- | S |

| Dynamic Characteristics | | | | | | |
|-------------------------|------------------------------|------------------------------------------------------------|--------|------|------|-------|
| Symbol | Parameter | Test Conditions | Rating | | | Units |
| | | | Min. | Typ. | Max. | |
| C_{iss} | Input Capacitance | $V_{GS}=0\text{V}, V_{DS}=25\text{V}$ $f=1.0\text{MHz}$ | -- | 1200 | -- | pF |
| C_{oss} | Output Capacitance | | -- | 60 | -- | |
| C_{rss} | Reverse Transfer Capacitance | | -- | 11 | -- | |

| Resistive Switching Characteristics | | | | | | |
|-------------------------------------|-----------------------------------|-----------------------------------------------------------------------------|--------|------|------|-------|
| Symbol | Parameter | Test Conditions | Rating | | | Units |
| | | | Min. | Typ. | Max. | |
| $t_{d(ON)}$ | Turn-on Delay Time | $I_D=0.75\text{A}, V_{DD}=100\text{V}$ $V_{GS}=10\text{V}, R_g=10\Omega$ | -- | 30 | -- | ns |
| t_r | Rise Time | | -- | 32 | -- | |
| $t_{d(OFF)}$ | Turn-Off Delay Time | | -- | 60 | -- | |
| t_f | Fall Time | | -- | 50 | -- | |
| Q_g | Total Gate Charge | $I_D=0.75\text{A}, V_{DD}=1000\text{V}$ $V_{GS}=10\text{V}$ | -- | 25 | -- | nC |
| Q_{gs} | Gate to Source Charge | | -- | 9 | -- | |
| Q_{gd} | Gate to Drain ("Miller") Charge | | -- | 15 | -- | |

| Source-Drain Diode Characteristics | | | | | | |
|---------------------------------------------------|----------------------------------------|-----------------------------------|--------|------|----------|-------|
| Symbol | Parameter | Test Conditions | Rating | | | Units |
| | | | Min. | Typ. | Max. | |
| I_{SD} | Continuous Source Current (Body Diode) | | -- | -- | 1.5 | A |
| I_{SM} | Maximum Pulsed Current (Body Diode) | | -- | -- | 5 | A |
| V_{SD} | Diode Forward Voltage | $I_S = 1.5A, V_{GS} = 0V$ | -- | -- | 5 | V |
| t_{rr} | Reverse Recovery Time | $I_S = 1.5A, T_j = 25^\circ C$ | -- | 1200 | -- | ns |
| Q_{rr} | Reverse Recovery Charge | $di/dt = 100A/\mu s, V_{GS} = 0V$ | -- | 7.1 | -- | uC |
| *Pulse width $t_p \leq 380\mu s, \delta \leq 2\%$ | | | | | | |

Characteristics Curve:

Fig. 1. Output Characteristics @ $T_J = @ 25^\circ\text{C}$

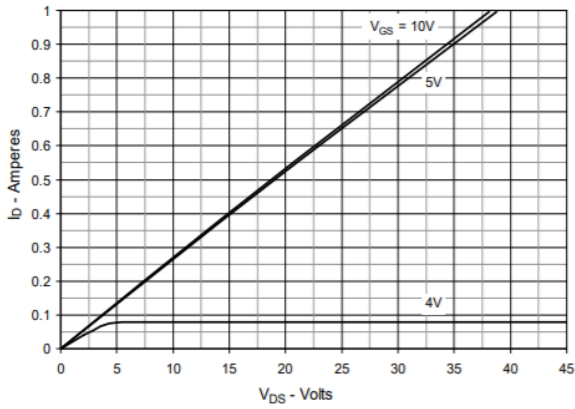

Fig. 2. Output Characteristics @ $T_J = 125^\circ\text{C}$

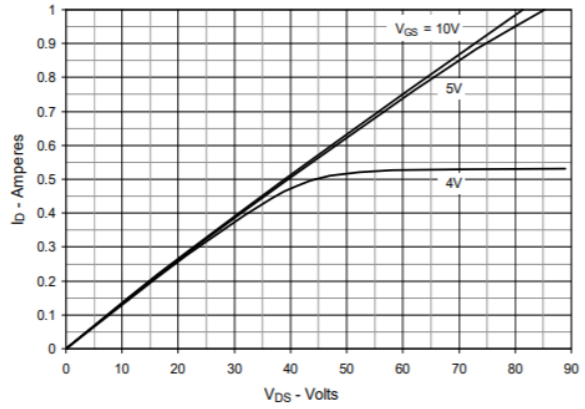

Fig. 4. $R_{DS(on)}$ Normalized to $I_D = 0.5\text{A}$ Value vs. Junction Temperature

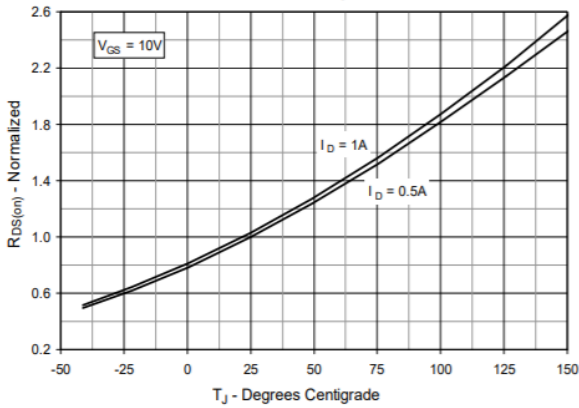

Fig. 3. $R_{DS(on)}$ Normalized to $I_D = 0.5\text{A}$ Value vs. Drain Current

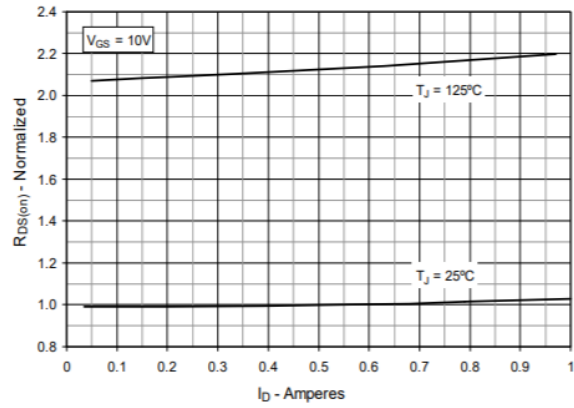

Fig. 5. Maximum Drain Current vs. Case Temperature

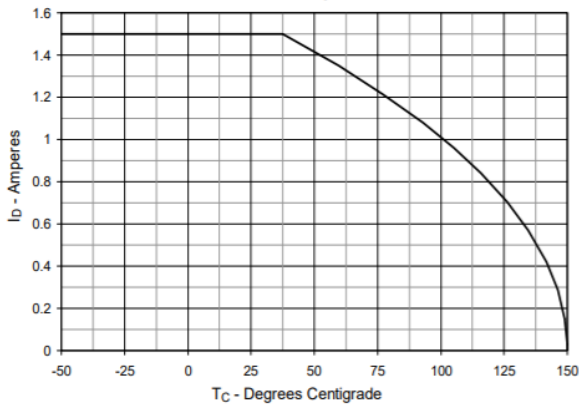

Fig. 6. Input Admittance

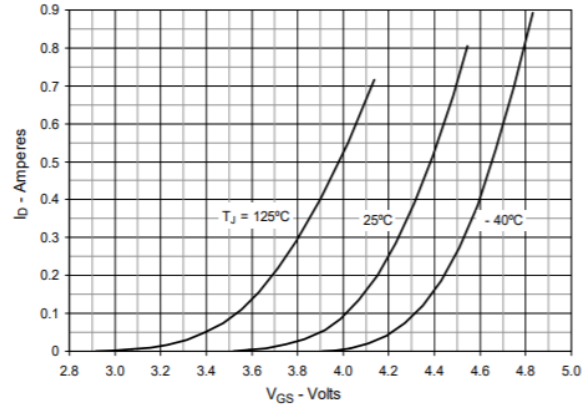

Fig. 7. Transconductance

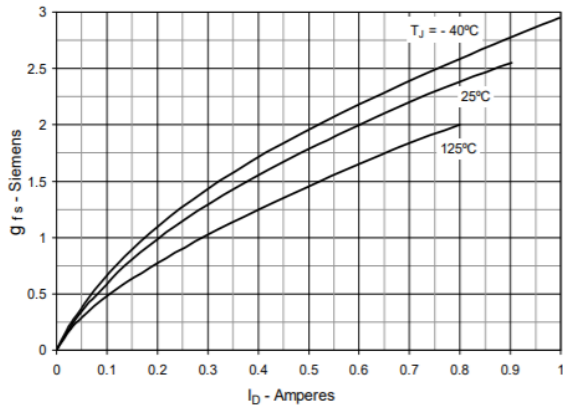

Fig. 8. Forward Voltage Drop of Intrinsic Diode

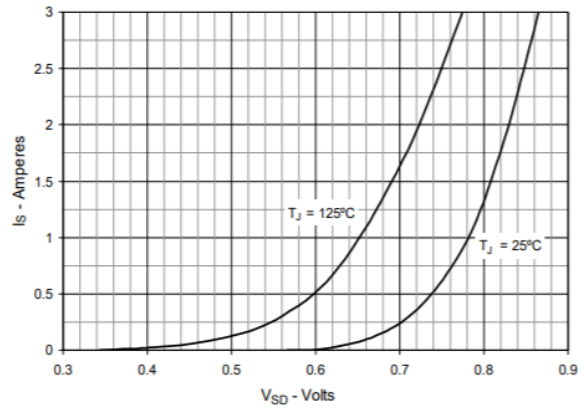

Fig. 9. Gate Charge

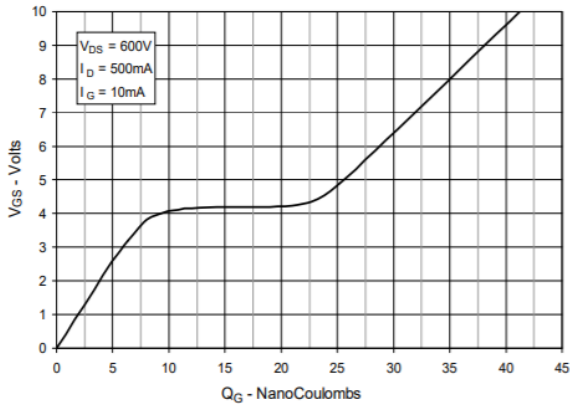

Fig. 10. Capacitance

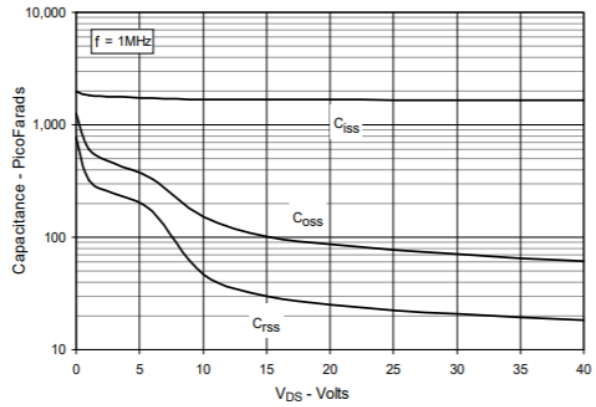

Fig. 11. Forward-Bias Safe Operating Area @ $T_C = 25^\circ\text{C}$

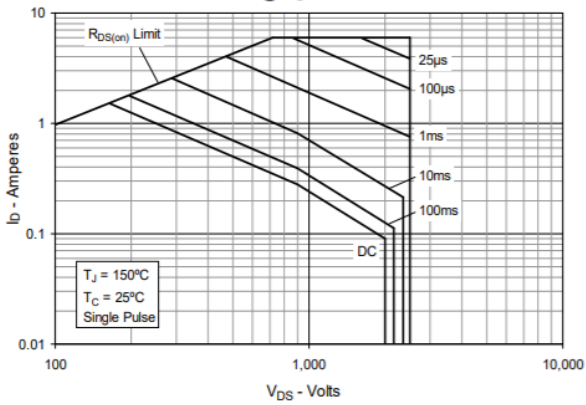

Fig. 12. Forward-Bias Safe Operating Area @ $T_C = 75^\circ\text{C}$

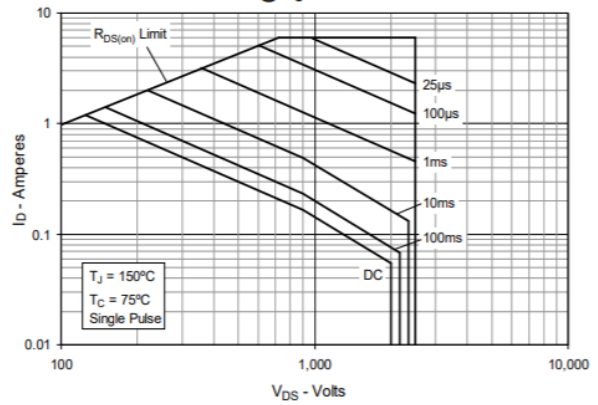

Fig. 13. Maximum Transient Thermal Impedance

