

General Description

The HMD004R10 uses Super Trench technology that is uniquely optimized to provide the most efficient high frequency switching performance. Both conduction and switching power losses are minimized due to an extremely low combination of $R_{DS(ON)}$ and Q_g . This device is ideal for high-frequency switching and synchronous rectification. The package form is TO-263, which accords with the RoHS standard.

V_{DSS}	100	V
I_D	180	A
P_D	300	W
$R_{DS(ON)MAX}$	4.0	m Ω

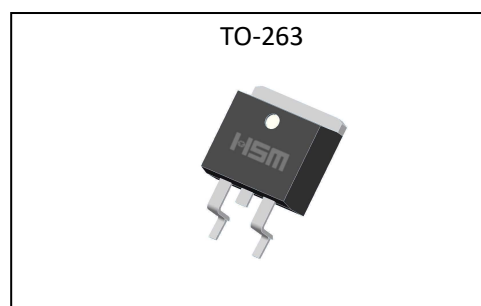

Features

- $R_{DS(ON)} < 4.0m\Omega$ @ $V_{GS}=10V$
- High density cell design for ultra low R_{dson}
- Fully characterized avalanche voltage and current
- Excellent package for good heat dissipation

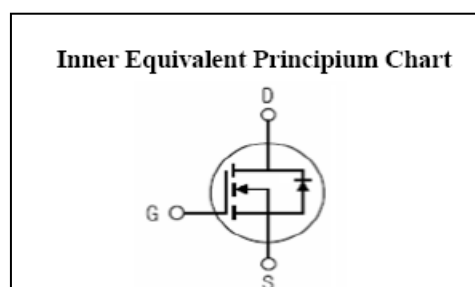

Applications

- Power switching application
- Hard switched and high frequency circuits
- Uninterruptible power supply

Absolute (Tc= 25°C unless otherwise specified)

Symbol	Parameter	Rating	Units
V_{DSS}	Drain-to-Source Voltage	100	V
I_D	Continuous Drain Current	180	A
I_{DM}	Pulsed Drain Current	720	A
V_{GS}	Gate-to-Source Voltage	± 20	V
P_D	Power Dissipation	300	W
E_{AS}	Single pulse avalanche energy ^{a5}	1000	mJ
T_J, T_{stg}	Operating Junction and Storage Temperature Range	175, -55 to 175	°C



Electrical Characteristics ($T_c = 25^\circ\text{C}$ unless otherwise specified)

OFF Characteristics						
Symbol	Parameter	Test Conditions	Rating			Units
			Min.	Typ.	Max.	
V_{DSS}	Drain to Source Breakdown Voltage	$V_{GS}=0V, I_D=250\mu A$	100	--	--	V
I_{DSS}	Drain to Source Leakage Current	$V_{DS}=100V, V_{GS}=0V, T_a=25^\circ\text{C}$	--	--	1.0	μA
$I_{GSS(F)}$	Gate to Source Forward Leakage	$V_{GS}=+20V$	--	--	0.1	μA
$I_{GSS(R)}$	Gate to Source Reverse Leakage	$V_{GS}=-20V$	--	--	-0.1	μA

ON Characteristics^{a3}						
Symbol	Parameter	Test Conditions	Rating			Units
			Min.	Typ.	Max.	
$R_{DS(ON)}$	Drain-to-Source On-Resistance	$V_{GS}=10V, I_D=100A$	--	--	4.0	$m\Omega$
$V_{GS(TH)}$	Gate Threshold Voltage	$V_{DS}=V_{GS}, I_D=250\mu A$	2.5	--	4.5	V

Pulse width $t_p \leq 380\mu s, \delta \leq 2\%$

Dynamic Characteristics^{a4}						
Symbol	Parameter	Test Conditions	Rating			Units
			Min.	Typ.	Max.	
g_{fs}	Forward Transconductance	$V_{DS}=10V, I_D=50A$	40	--	--	S
C_{iss}	Input Capacitance	$V_{GS}=0V, V_{DS}=50V$ $f=1.0\text{MHz}$	--	11500	--	pF
C_{oss}	Output Capacitance		--	2480	--	
C_{rss}	Reverse Transfer Capacitance		--	75	--	

Resistive Switching Characteristics^{a4}						
Symbol	Parameter	Test Conditions	Rating			Units
			Min.	Typ.	Max.	
$t_{d(ON)}$	Turn-on Delay Time	$V_{DD}=50V, I_D=100A$ $V_{GS}=10V, R_G=1.6\Omega$	--	35	--	ns
t_r	Rise Time		--	59	--	
$t_{d(OFF)}$	Turn-Off Delay Time		--	89	--	
t_f	Fall Time		--	29	--	
Q_g	Total Gate Charge	$V_{DD}=50V, I_D=100A$ $V_{GS}=10V$	--	160	--	nC
Q_{gs}	Gate to Source Charge		--	52	--	
Q_{gd}	Gate to Drain ("Miller") Charge		--	29	--	



Source-Drain Diode Characteristics

Symbol	Parameter	Test Conditions	Rating			Units
			Min.	Typ.	Max.	
I_S	Continuous Source Current ^{a2} (Body Diode)		--	--	180	A
V_{SD}	Diode Forward Voltage ^{a3}	$I_S=180A, V_{GS}=0V$	--	--	1.2	V

Symbol	Parameter	Typ.	Units
$R_{\theta JC}$	Junction-to-Case ^{a2}	0.5	°C/W

^{a1}: Repetitive Rating: Pulse width limited by maximum junction temperature.

^{a2}: Surface Mounted on FR4 Board, $t \leq 10\text{sec}$.

^{a3}: Pulse Test: Pulse Width $\leq 300\mu\text{s}$, Duty Cycle $\leq 2\%$.

^{a4}: Guaranteed by design, not subject to production

^{a5}: EAS condition: $T_j=25^\circ\text{C}, V_{DD}=50V, V_G=10V, L=0.5\text{mH}, R_g=25\Omega$

Test circuit

1) EAS test Circuit

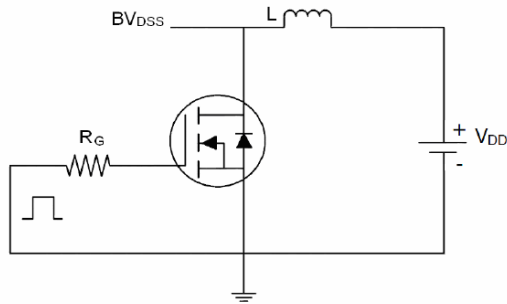

2) Gate charge test Circuit

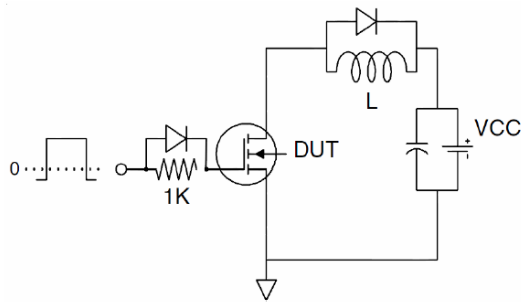

3) Switch Time Test Circuit

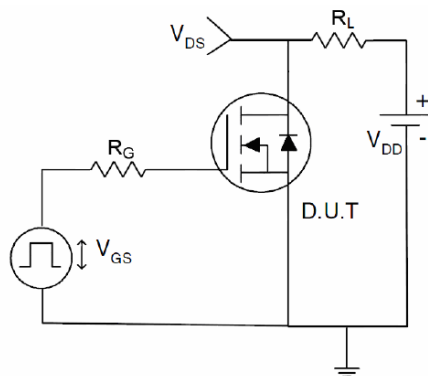

Characteristics Curve

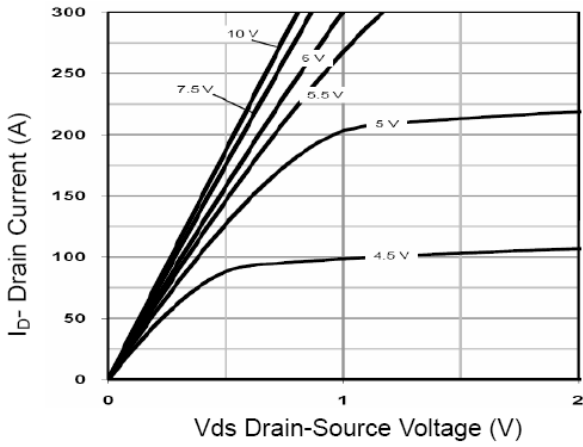

Figure 1 Output Characteristics

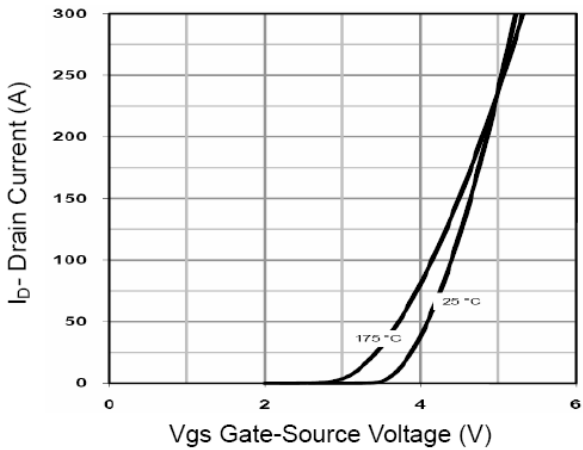

Figure 2 Transfer Characteristics

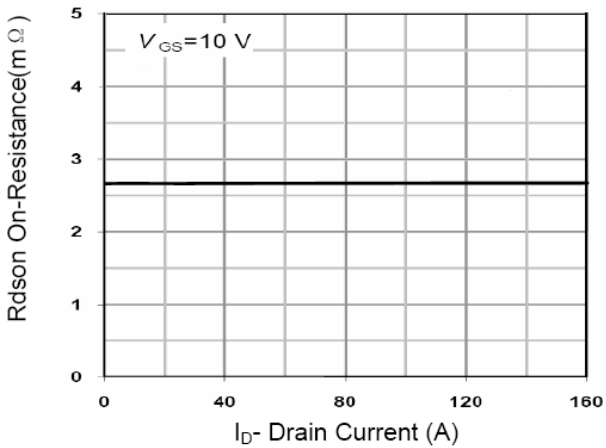

Figure 3 Rdson- Drain Current

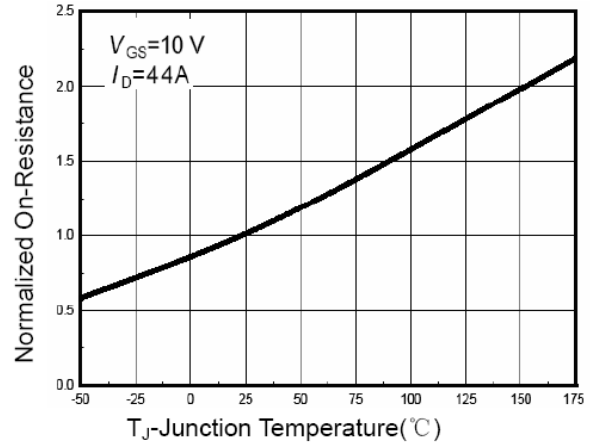

Figure 4 Rdson-Junction Temperature

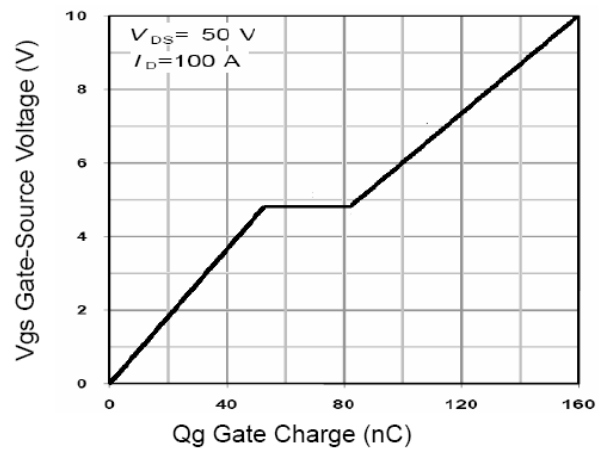

Figure 5 Gate Charge

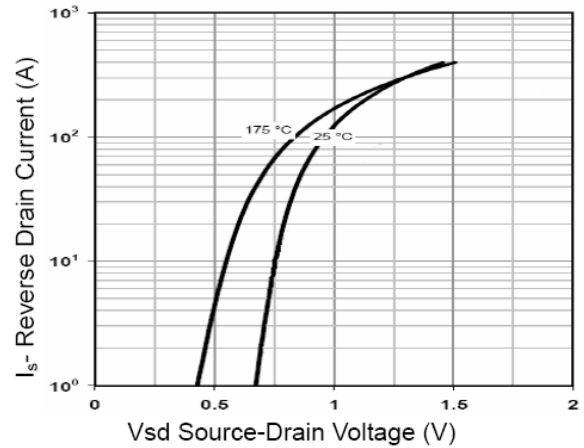

Figure 6 Source- Drain Diode Forward

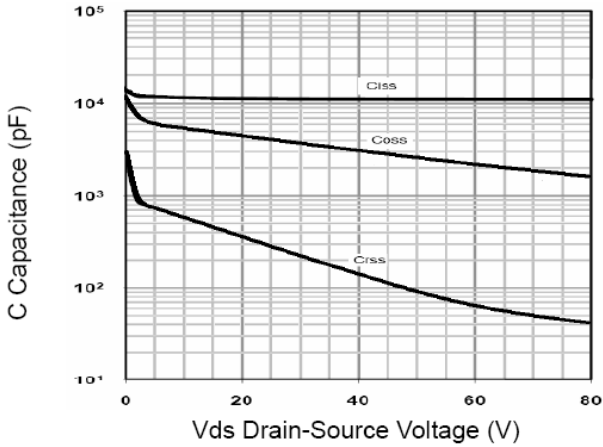

Figure 7 Capacitance vs Vds

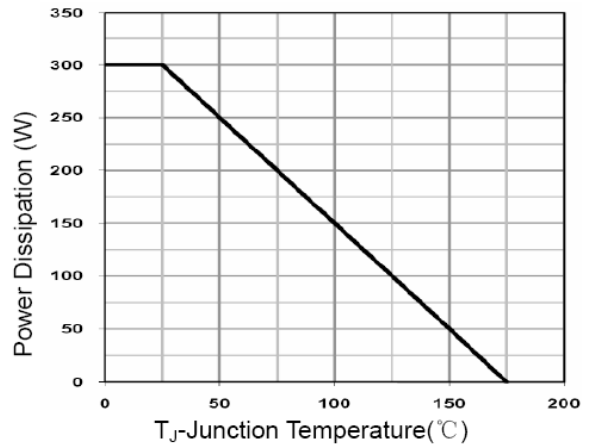

Figure 9 Power De-rating

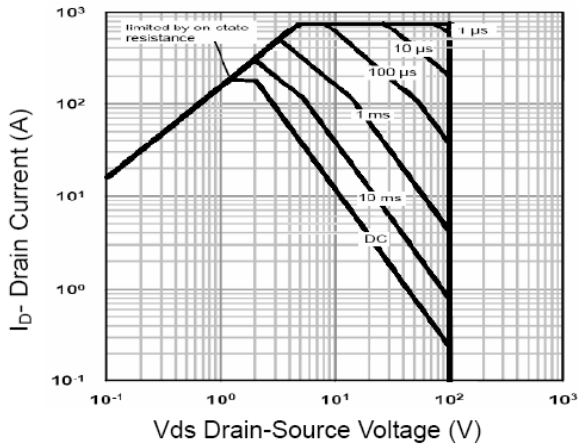

Figure 8 Safe Operation Area

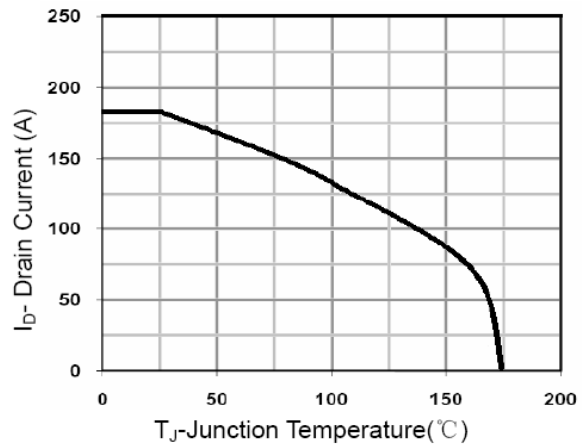

Figure 10 Current De-rating

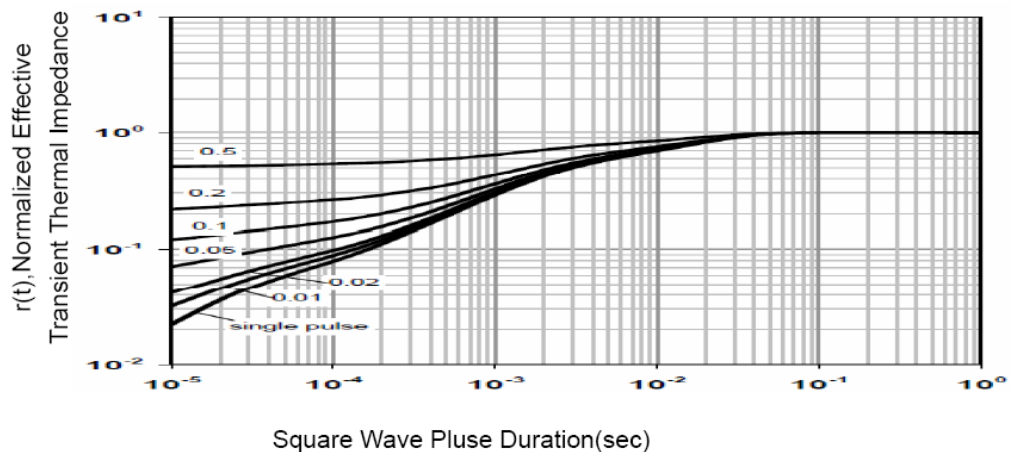

Figure 11 Normalized Maximum Transient Thermal Impedance